

XBee® Wi-Fi RF Module



WiFi RF Modules by Digi International
Firmware version: 102x



11001 Bren Road East
Minnetonka, MN 55343
877 912-3444 or 952 912-3444
<http://www.digi.com>

© 2011 Digi International, Inc. All rights reserved

No part of the contents of this manual may be transmitted or reproduced in any form or by any means without the written permission of Digi International, Inc.

XBee® is a registered trademark of Digi International, Inc.

Technical Support Phone: (866) 765-9885 toll-free U.S.A. & Canada

(801) 765-9885 Worldwide

8:00 am - 5:00 pm [U.S. Mountain Time]

Online Support: <http://www.digi.com/support/eservice/login.jsp>

Email: rf-experts@digi.com

Contents

XBee® Wi-Fi RF Module	1
1. Overview.....	7
Specifications.....	8
General Specifications	8
RF Specifications.....	8
Electrical Specifications	10
Serial Communications Specifications.....	11
UART	11
SPI.....	11
GPIO Specifications.....	12
Agency Approvals	13
Pin Signals	13
Design Notes.....	14
Power Supply.....	14
Recommended Pin Connections	14
Board Layout	15
Mounting Considerations.....	17
2. RF Module Operation	18
Serial Communications.....	18
UART Communications.....	18
SPI Communications.....	19
Serial Buffers	20
Serial Receive Buffer.....	21
Serial Transmit Buffer.....	21
UART Flow Control	21
Serial Interface Protocols	22
Transparent Operation.....	23
API Operation	23
A Comparison of Transparent and API Operation.....	24
Modes of Operation	24
Idle Mode	24
Transmit Mode	25
Receive Mode.....	25
Command Mode.....	25

Sleep Mode.....	26
3. 802.11 bgn Networks	27
Infrastructure Networks	27
Ad Hoc Networks.....	27
Network Basics	28
XBee® Wi-Fi Standards	28
Encryption	29
Channels	29
4. XBee IP Services.....	31
XBee Application Service	31
Local Host	31
Network Client.....	32
Serial Communication Service.....	34
Transparent mode	34
API mode	35
5. Sleep	36
Sleeping with the UART	36
Sleeping with the SPI	36
Sleep Options	37
AP Associated sleep.....	37
Deep sleep (non-associated sleep).....	38
Sampling data using sleep modes	38
Sample Rate (ATIR).....	38
Wake Host	38
6. XBee Analog and Digital IO Lines.....	39
IO Sampling.....	40
Queried Sampling	41
Periodic IO Sampling.....	42
I/O Examples.....	42
7. API Operation	43
API Frame Specifications	43
API UART and SPI Exchanges	46
AT Commands.....	46
Transmitting and Receiving RF Data.....	46
Remote AT commands	46

Supporting the API.....	47
API Frames.....	47
TX (Transmit) request: 64-Bit	47
AT Command	49
AT Command-Queue Parameter Value	50
Remote AT Command Request	51
Transmit (TX) request: IPv4	52
Rx (Receive) Packet: 64-bit	53
AT Command Response.....	54
Modem Status	55
Transmission Status.....	56
IO Data Sample RX Indicator	57
Remote Command Response	59
RX (Receive) Packet: IPv4	60
8. XBee Command Reference Tables.....	61
Addressing	61
Networking Commands	62
Security Commands.....	62
RF Interfacing Commands	62
Serial Interfacing.....	63
I/O Settings	64
Diagnostics Interfacing	67
AT Command Options	68
Sleep Commands	68
Execution Commands	69
9. Module Support.....	70
X-CTU Configuration Tool	70
Serial Firmware Updates	70
Regulatory Compliance	70
10. Agency Certifications.....	71
United States FCC	71
OEM Labeling Requirements.....	71
FCC-Approved Antennas (2.4 GHz).....	72
Europe (ETSI)	76
OEM Labeling Requirements.....	76

Restrictions	76
Declarations of Conformity	76
Approved Antennas	77
XBee Wi-Fi RF Module	77
Antenna Type: Yagi	77
Antenna Type: Omni-Directional	77
Antenna Type: Flat Panel	77
XBee RF Module	77
Canada (IC)	78
Labeling Requirements	78
Transmitters with Detachable Antennas	78
Australia (C-Tick)	79
Japan (TELEC)	79
Approved Antennas Table	79
11. Warranty Information	80
1-Year Warranty	80
12. Glossary of Terms	81
Definitions	81

1. Overview

The XBee® Wi-Fi RF module provides wireless connectivity to end-point devices in 802.11 bgn networks. Using the 802.11 feature set, these modules are interoperable with other 802.11 bgn devices, including devices from other vendors. With XBee, users can have their 802.11 bgn network up-and running in a matter of minutes.

The XBee® Wi-Fi modules are compatible with other devices that use 802.11 bgn technology. These include Digi external 802.11x devices like the ConnectPort products and the Digi Connect Wi-SP, as well as embedded products like the ConnectCore series and Digi Connect series of products. More information on these Digi products can be found at:

<http://www.digi.com/products/wireless/wifisolutions/>

Specifications

General Specifications

Specification	XBee Wi-Fi
Dimensions	0.960 x 1.297 (2.438cm x 3.294cm)
Operating Temperature	-40 to 85° C (Industrial)
Antenna Options	PCB Antenna, U.FL Connector, RPSMA Connector, or Integrated Wire

RF Specifications

Specification	XBee Wi-Fi																																								
Frequency	ISM 2.4-2.5GHz																																								
Number of Channels	14																																								
Channels	1 to 14																																								
Adjustable Power	Yes																																								
Interface immunity	802.11 b, g, and n																																								
Indoor/Urban Range	Up to 400 Ft / 120 m																																								
Transmit Power Output	>15dBm																																								
RF Data Rate	802.11 b 1, 2, 5.5, and 11Mbps 802.11 g 6, 9, 12, 18, 24, 36, 48, and 54 Mbps 802.11 n 6.5, 13, 19.5, 26, 39, 52, 58.5, and 65 Mbps																																								
EVM	<table border="0"> <tr><td>802.11 b 1Mbps</td><td>8%</td></tr> <tr><td>802.11 b 2Mbps</td><td>17%</td></tr> <tr><td>802.11 b 5.5Mbps</td><td>10%</td></tr> <tr><td>802.11 b 11Mbps</td><td>12%</td></tr> <tr><td>802.11 g 6Mbps</td><td>-13dB</td></tr> <tr><td>802.11 g 9Mbps</td><td>-15dB</td></tr> <tr><td>802.11 g 12Mbps</td><td>-16dB</td></tr> <tr><td>802.11 g 18Mbps</td><td>-18dB</td></tr> <tr><td>802.11 g 24Mbps</td><td>-19dB</td></tr> <tr><td>802.11 g 36Mbps</td><td>-21dB</td></tr> <tr><td>802.11 g 48Mbps</td><td>-24dB</td></tr> <tr><td>802.11 g 54 Mbps</td><td>-25dB</td></tr> <tr><td>802.11 n MCS0 6.5Mbps</td><td>-15dB</td></tr> <tr><td>802.11 n MCS1 13Mbps</td><td>-16dB</td></tr> <tr><td>802.11 n MCS2 19.5Mbps</td><td>-17dB</td></tr> <tr><td>802.11 n MCS3 26Mbps</td><td>-19dB</td></tr> <tr><td>802.11 n MCS4 39Mbps</td><td>-20dB</td></tr> <tr><td>802.11 n MCS5 52Mbps</td><td>-21dB</td></tr> <tr><td>802.11 n MCS6 58Mbps</td><td>-23dB</td></tr> <tr><td>802.11 n MCS7 65Mbps</td><td>-24dB</td></tr> </table>	802.11 b 1Mbps	8%	802.11 b 2Mbps	17%	802.11 b 5.5Mbps	10%	802.11 b 11Mbps	12%	802.11 g 6Mbps	-13dB	802.11 g 9Mbps	-15dB	802.11 g 12Mbps	-16dB	802.11 g 18Mbps	-18dB	802.11 g 24Mbps	-19dB	802.11 g 36Mbps	-21dB	802.11 g 48Mbps	-24dB	802.11 g 54 Mbps	-25dB	802.11 n MCS0 6.5Mbps	-15dB	802.11 n MCS1 13Mbps	-16dB	802.11 n MCS2 19.5Mbps	-17dB	802.11 n MCS3 26Mbps	-19dB	802.11 n MCS4 39Mbps	-20dB	802.11 n MCS5 52Mbps	-21dB	802.11 n MCS6 58Mbps	-23dB	802.11 n MCS7 65Mbps	-24dB
802.11 b 1Mbps	8%																																								
802.11 b 2Mbps	17%																																								
802.11 b 5.5Mbps	10%																																								
802.11 b 11Mbps	12%																																								
802.11 g 6Mbps	-13dB																																								
802.11 g 9Mbps	-15dB																																								
802.11 g 12Mbps	-16dB																																								
802.11 g 18Mbps	-18dB																																								
802.11 g 24Mbps	-19dB																																								
802.11 g 36Mbps	-21dB																																								
802.11 g 48Mbps	-24dB																																								
802.11 g 54 Mbps	-25dB																																								
802.11 n MCS0 6.5Mbps	-15dB																																								
802.11 n MCS1 13Mbps	-16dB																																								
802.11 n MCS2 19.5Mbps	-17dB																																								
802.11 n MCS3 26Mbps	-19dB																																								
802.11 n MCS4 39Mbps	-20dB																																								
802.11 n MCS5 52Mbps	-21dB																																								
802.11 n MCS6 58Mbps	-23dB																																								
802.11 n MCS7 65Mbps	-24dB																																								
Receiver Sensitivity	802.11 b 1Mbps -97dBm (<8% PER) 802.11 b 2Mbps -93dBm (<8% PER)																																								

	802.11 b 11Mbps	-89dBm (<8% PER)
	802.11 g 6Mbps	-91dBm (<10% PER)
	802.11 g 54 Mbps	-75dBm (<10% PER)
	802.11 n 65Mbps	-72dBm (<10% PER)

Spectral Mask	XBee Wi-Fi								
Data Rate	-50 to 22 MHz	-22 to -11 MHz	11 To 22 MHz	22 to 50 MHz	Units				
802.11 b 1Mbps	-52	-39	-39	-52	dBc				
802.11 b 2Mbps	-52	-38	-38	-54	dBc				
802.11 b 5.5Mbps	-56	-43	-48	-54	dBc				
802.11 b 11Mbps	-54	-39	-37	-55	dBc				
Data Rate	-50 to -30 MHz	-30 to -20 MHz	-20 to -11 MHz	-11 to -9 MHz	9 to 11 MHz	11 to 20 MHz	20 to 30 MHz	30 to 50 MHz	Units
802.11 g 6Mbps	-46	-43.5	-28.5	-16.5	-16.5	-27.5	-42.5	-47	dBc
802.11 g 9Mbps	-46	-42.5	-27.5	-17.5	-16.5	-27.5	-42.5	-46	dBc
802.11 g 12Mbps	-46	-42.5	-28.5	-17.5	-17.5	-27.5	-41.5	-47	dBc
802.11 g 18Mbps	-46	-42.5	-27.5	-17.5	-17.5	-27.5	-41.5	-45	dBc
802.11 g 24Mbps	-47	-44.5	-30.5	-19.5	-19.5	-30.5	-43.5	-47	dBc
802.11 g 36Mbps	-47	-44.5	-30.5	-21.5	-21.5	-30.5	-46.5	-49	dBc
802.11 g 48Mbps	-47	-48.5	-36.5	-23.5	-24.5	-36.5	-48.5	-52	dBc
802.11 g 54Mbps	-47	-48.5	-33.5	-24.5	-23.5	-33.5	-49.5	-49	dBc
802.11 n MCS0 6.5Mbps	-45	-39.5	-26.5	-16.5	-16.5	-26.5	-39.5	-45	dBc
802.11 n MCS1 13Mbps	-44	-40.5	-26.5	-16.5	-15.5	-25.5	-39.5	-45	dBc
802.11 n MCS2 19.5Mbps	-44	-41.5	-27.5	-16.5	-16.5	-27.5	-40.5	-45	dBc
802.11 n MCS3 26Mbps	-44	-40.5	-27.5	-16.5	-16.5	-25.5	-38.5	-45	dBc
802.11 n MCS4 39Mbps	-45	-42.5	-30.5	-19.5	-19.5	-29.5	-42.5	-47	dBc
802.11 n MCS5 52Mbps	-46	-43.5	-30.5	-18.5	-18.5	-29.5	-43.5	-46	dBc
802.11 n MCS6 58Mbps	-47	-45.5	-34.5	-22.5	-22.5	-33.5	-46.5	-48	dBc
802.11 n MCS7 65Mbps	-47	-46.5	-34.5	-22.5	-22.5	-33.5	-46.5	-49	dBc

Electrical Specifications

Specification	XBee Wi-Fi
Supply Voltage	3.1 - 3.6 V
Operating Current (transmit, max output power)	802.11 b 1Mbps 260mA
	802.11 b 2Mbps 260mA
	802.11 b 5.5Mbps 260mA
	802.11 b 11Mbps 260mA
	802.11 g 6Mbps 240mA
	802.11 g 9Mbps 220mA
	802.11 g 12Mbps 210mA
	802.11 g 18Mbps 200mA
	802.11 g 24Mbps 190mA
	802.11 g 36Mbps 180mA
	802.11 g 48Mbps 170mA
	802.11 g 54 Mbps 170mA
	802.11 n MCS0 6.5Mbps 230mA
	802.11 n MCS1 13Mbps 210mA
	802.11 n MCS2 19.5Mbps 200mA
	802.11 n MCS3 26Mbps 200mA
	802.11 n MCS4 39Mbps 190mA
	802.11 n MCS5 52Mbps 180mA
802.11 n MCS6 58Mbps 180mA	
802.11 n MCS7 65Mbps 180mA	
Operating Current (Receive)	140mA
Deep Sleep Current	<2uA @25C

Serial Communications Specifications

The XBee Wi-Fi RF modules support both UART (Universal Asynchronous Receiver/Transmitter) and SPI slave mode (Serial Peripheral Interface in slave mode only) serial connections.

UART

Specification	XBee Wi-Fi
UART Pins	Module Pin Number
DOUT/DIO13	2
DIN/DIO14	3
nCTS/DIO7	12
nRTS/DIO6	16

More information on UART operation is found in the UART section in chapter 2.

SPI

Specification	XBee Wi-Fi
SPI Pins	Module Pin Number
SPI_SCLK/DIO2	18
SPI_nSSEL/DIO3	17
SPI_MOSI/DIO4	11
SPI_MISO/DIO12	4
SPI_nATTN/DIO1	19

For more information on SPI operation see the SPI section in chapter 2.

GPIO Specifications

The XBee Wi-Fi modules have 14 GPIO (General Purpose Input Output) ports available. Those available will depend on the module configuration as some GPIO's are consumed by serial communication, etc.

See GPIO section for more information on configuring and using GPIO ports

Electrical Specification for GPIO pads

Parameter	Condition	Min	Typ	Max	Units
Input Low Voltage				0.3VDD	V
Input High Voltage		0.7VDD			V
Output high Voltage relative to VDD	Sourcing 6mA, VDD=3.0V	95			%
Output low voltage relative to VDD	Sourcing 6mA, VDD=3.0V			5	%
Output fall time	0.5 mA drive strength and load capacitance CL=12.5-25pF.	20+0.1CL		250	ns
	2 mA drive strength and load capacitance CL=350-600pF.	20+0.1CL		250	ns
I/O pin hysteresis (VIOTHR+ - Viothr-)	VDD=3 to 3.6V	0.1VDD			V
Pulse width of pulses to be removed by the glitch suppression filter		10		50	ns

Agency Approvals

Specification	XBee Wi-Fi
United States (FCC Part 15.247)	FCC ID: MCQ-XBS6
Industry Canada (IC)	IC: 1846A-XBS6
Europe (DC)	ETSI
Australia	C-tick
Brazil	Pending
Japan	TELEC

FCC Approval (USA) Refer to Chapter 12 FCC Requirements. Systems that contain XBee Wi-Fi modules inherit Digi Certifications.

Pin Signals

Pin Assignment for the XBee Wi-Fi module

(Low-asserted signals are distinguished with a lower case n before the signal name.)

Pin #	Name	Direction	Default State	Description
1	VCC	-	-	Power Supply
2	DOUT/DIO13	Both	Output	UART Data out
3	Din/nConfig/DIO14	Both	Input	UART Data In
4	DIO12/SPI_MISO	Both	Output	GPIO/ SPI slave out
5	nRESET	Input		Module Reset
6	DIO10/PWM0	Both		GPIO
7	DIO11/PWM1	Both		GPIO
8	reserved	-	Disabled	Do Not Connect
9	nDTR/SLEEP_RQ/DIO8	Both	Input	Pin Sleep Control line /GPIO
10	GND	-	-	Ground
11	DIO4/AD4/SPI_MOSI	Both		GPIO/SPI slave In
12	nCTS/DIO7	Both	Output	Clear-to-Send Flow Control/GPIO
13	On_nSLEEP/DIO9	Output	Output	Module Status Indicator/GPIO
14	VREF	Input	-	NC
15	Associate/DIO5	Both	Output	Associate Indicator/GPIO
16	nRTS/DIO6	Both	Input	Request-to-Send Flow Control/GPIO
17	AD3/DIO3/SPI_nSSEL	Both		Analog Input/GPIO/SPI Slave Select
18	AD2/DIO2/SPI_CLK	Both		Analog Input/GPIO/SPI Clock
19	AD1/DIO1/SPI_nATTN	Both		Analog Input/GPIO/SPI Attention
20	AD0/DIO0	Both		Analog Input/GPIO

Design Notes

The XBee modules do not specifically require any external circuitry or specific connections for proper operation. However, there are some general design guidelines that are recommended for help in troubleshooting and building a robust design.

Power Supply

Poor power supply can lead to poor radio performance especially if the supply voltage is not kept within tolerance or is excessively noisy. To help reduce noise a 1uF and 8.2pF capacitor are recommended to be placed as near to pin 1 on the PCB as possible. If using a switching regulator for your power supply, switching frequencies above 500 kHz are preferred. Power supply ripple should be limited to a maximum 50mV peak to peak.

Typical start up current for the module is shown in the graph below:

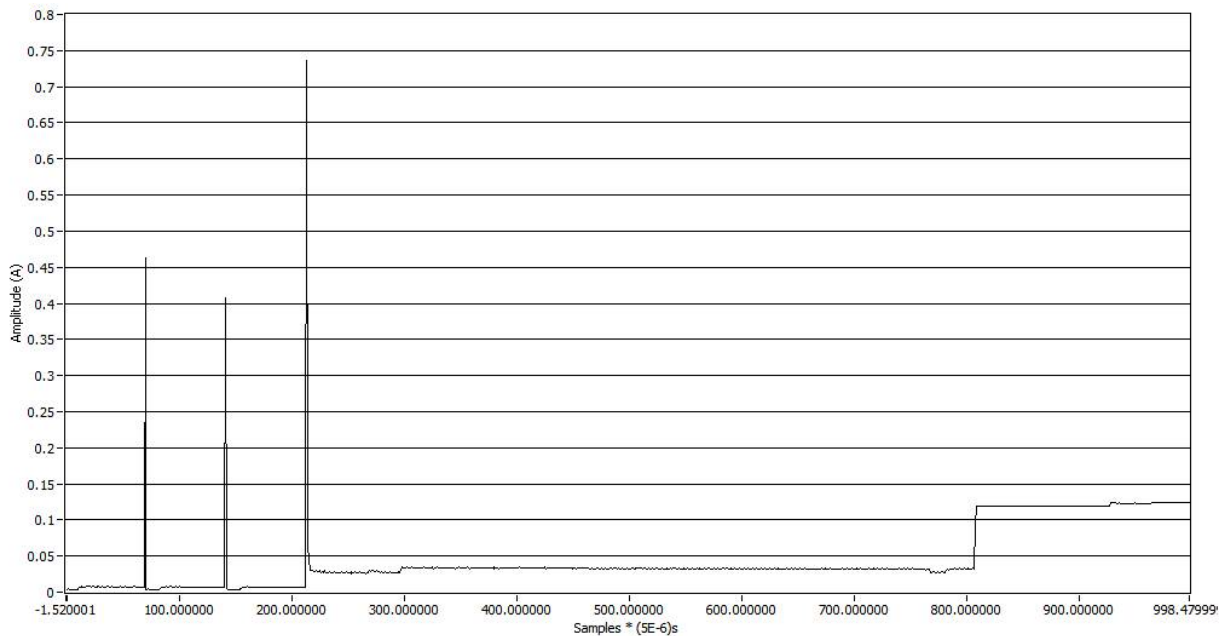

Due to the fast nature of the current peaks, it is recommended that at least a 500uF capacitor be placed on the VCC line. This will enable the XBee to start up with an acceptable voltage slump in the power supply.

Recommended Pin Connections

The only required pin connections are VCC, GND, and either DOUT and DIN or SPI_CLK, SPI_nSSEL, SPI_MOSI, and SPI_MISO. To support serial firmware updates, VCC, GND, DOUT, DIN, RTS, and DTR should be connected.

All unused pins should be left disconnected. All inputs on the radio can be pulled high with 30k internal pull-up resistors using the PR software command. No specific treatment is needed for unused outputs.

For applications that need to ensure the lowest sleep current, inputs should never be left floating. Use internal or external pull-up or pull-down resistors, or set the unused I/O lines to outputs.

Other pins may be connected to external circuitry for convenience of operation including the Associate pin (pin 15) and the On_nSLEEP pin (pin 13) will change level or behavior based on the state of the module.

Board Layout

XBee modules do not have any specific sensitivity to nearby processors, crystals or other PCB components. Other than mechanical considerations, no special PCB placement is required for integrating XBee radios except for those with integral antennas. In general, Power and GND traces should be thicker than signal traces and be able to comfortably support the maximum currents.

The radios are also designed to be self sufficient and work with the integrated and external antennas without the need for additional ground planes on the host PCB. However, considerations should be taken on the choice of antenna and antenna location. Metal objects that are near an antenna cause reflections and may reduce the ability for an antenna to efficiently radiate. Using an integral antenna in an enclosed metal box will greatly reduce the range of a radio. For this type of application an external antenna would be a better choice.

External antennas should be positioned away from metal objects as much as possible. Metal objects next to the antenna or between transmitting and receiving antennas can often block or reduce the transmission distance. Some objects that are often overlooked are metal poles, metal studs or beams in structures, concrete (it is usually reinforced with metal rods), metal enclosures, vehicles, elevators, ventilation ducts, refrigerators and microwave ovens.

Antennas should reside above or away from any metal objects like batteries, tall electrolytic capacitors or metal enclosures. Antenna elements radiate perpendicular to the direction they point. Thus a vertical antenna emits across the horizon.

PCB Antennas should not have any ground planes or metal objects above or below the module at the antenna location. For best results the module should be in a plastic enclosure, instead of metal one. It should be placed at the edge of the PCB to which it is mounted. The ground, power and signal planes should be vacant immediately below the antenna section (See the following drawing for recommended keep out area).

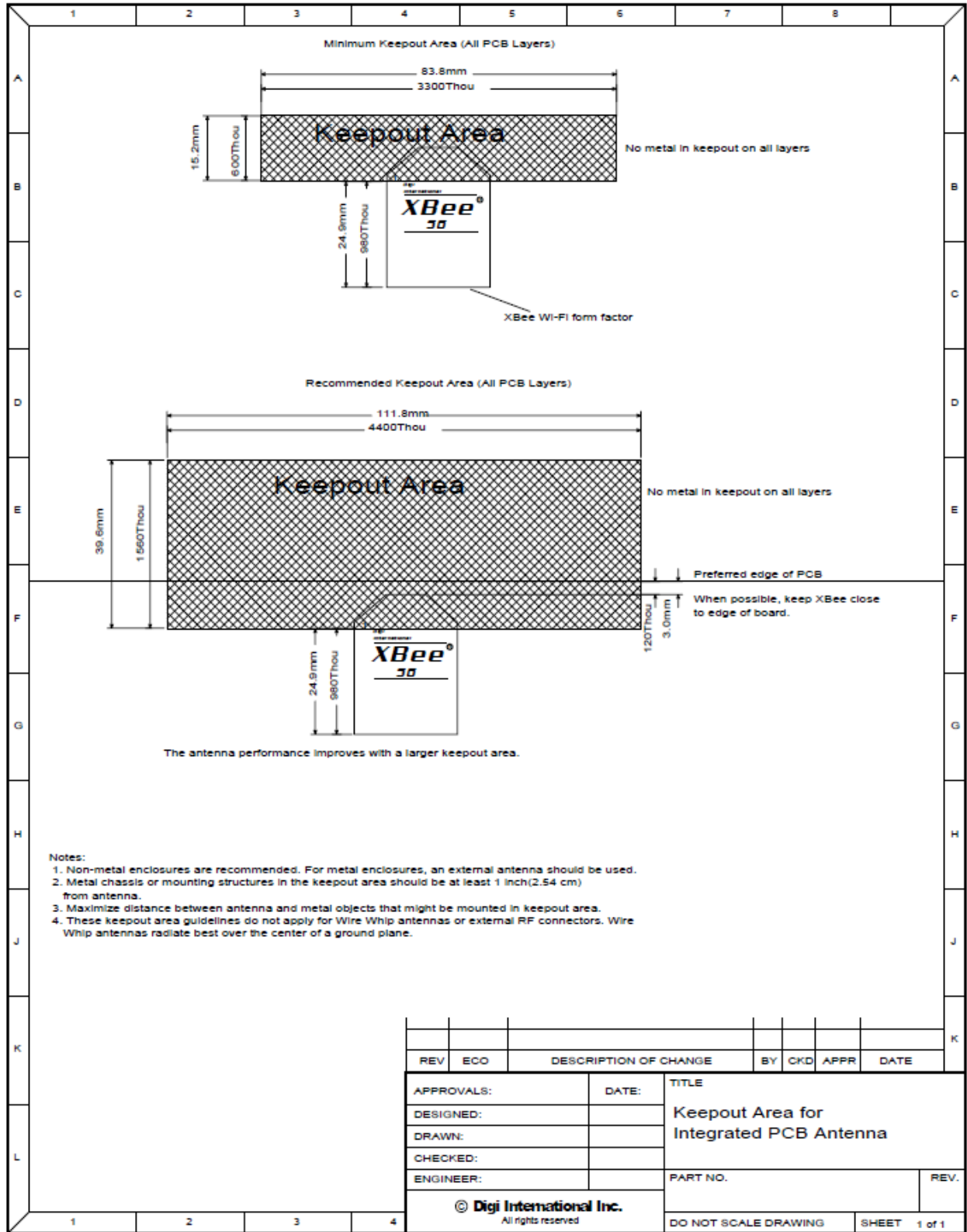

Mounting Considerations

XBee modules were designed to mount into a receptacle (socket) and therefore do not require any soldering when mounting to a board. The XBee Wi-Fi Development Kits contain 2 USB interface boards which use two 10-pin receptacles to receive modules.

The receptacles used on Digi development boards are manufactured by Century Interconnect. Several other manufacturers provide comparable mounting solutions; however, Digi currently uses the following receptacles:

- Through-hole single-row receptacles - Samtec P/N: MMS-110-01-L-SV (or equivalent)
- Through-hole single-row receptacles - Mill-Max P/N: 831-43-0101-10-001000
- Surface-mount double-row receptacles - Century Interconnect P/N: CPRMSL20-D-0-1 (or equivalent)
- Surface-mount single-row receptacles - Samtec P/N: SMM-110-02-SM-S

Digi also recommends printing an outline of the module on the board to indicate the orientation the module should be mounted.

2. RF Module Operation

Serial Communications

The XBee RF Modules interface to a host device through a logic-level asynchronous serial port, or a Serial Peripheral Interface (SPI) port. Through its serial ports, the module can communicate with any logic and voltage compatible UART or SPI; or through a level translator to any serial device (for example: through a RS-232 or USB interface board).

UART Communications

UART Data Flow

Devices that have a UART interface can connect directly to the pins of the RF module as shown in the figure below.

System Data Flow Diagram in a UART-interfaced environment
(Low-asserted signals distinguished with horizontal line over signal name.)

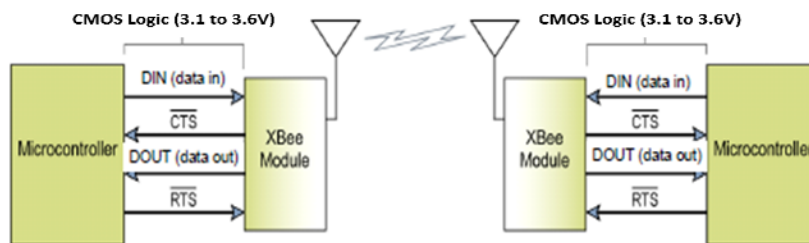

UART Serial Data

Data enters the module UART through the DIN (pin 3) as an asynchronous serial signal. The signal should idle high when no data is being transmitted.

Each data byte consists of a start bit (low), 8 data bits (least significant bit first) and a stop bit (high). The following figure illustrates the serial bit pattern of data passing through the module.

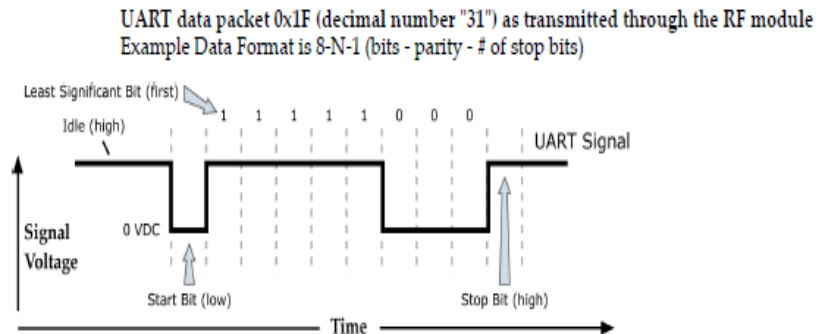

Serial communications depend on the two UARTs (the microcontroller's and the RF module's) to be configured with compatible settings (baud rate, parity, start bits, stop bits, data bits).

The UART baud rate, parity, and stop bits settings on the XBee module can be configured with the BD, NB, and SB commands respectively. See the command table in chapter 10 for details.

SPI Communications

The XBee Wi-Fi module supports SPI communications in the slave mode. Slave mode receives the clock signal and data from the master and returns data to the master. The SPI port uses the following signals on the XBee:

- SPI_MOSI (Master Out, Slave In) – inputs serial data from the master
- SPI_MISO (Master In, Slave Out) – outputs serial data to the master
- SPI_SCLK (Serial Clock) – clocks data transfers on MOSI and MISO
- SPI_nSSEL (Slave Select) – enables serial communication with the slave
- SPI_nATTN(Attention) – alerts the master that slave has data queued to send. The XBee module will assert this pin as soon as data is available to send to the SPI master and it will remain asserted until the SPI master has clocked out all available data.

In this mode the following apply:

- SPI Clock rates up to 3.5 MHz are possible.
- Data is MSB first
- Frame Format mode 0 is used. This means CPOL=0 (idle clock is low) and CPHA=0 (data is sampled on the clock's leading edge). Mode 0 is diagramed below.
- SPI port is setup for API mode and is equivalent to AP=1.

Frame Format for SPI communications

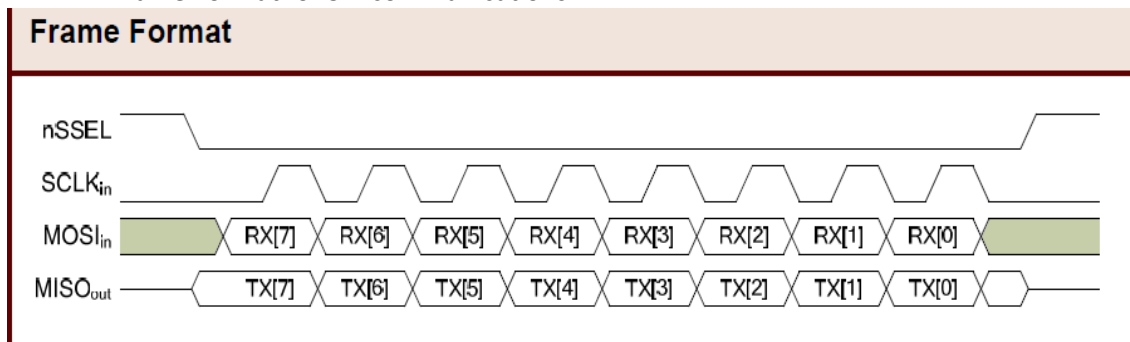

SPI mode is chip to chip communication. Digi does not supply SPI communication option on the Device Development Evaluation Boards.

SPI mode can be forced by holding DOUT/DIO13 (pin 2) low while resetting the module until SPI_nATTN asserts. By this means, the XBee Wi-Fi module will disable the UART and go straight into SPI communication mode. Once configuration is completed, a modem status frame is queued by the module to the SPI port which will cause the SPI_nATTN line to assert. The host can use this to determine that the SPI port has been configured properly. This method internally forces the configuration to provide full SPI support for the following parameters:

- D1 (note this parameter will only be changed if it is at a default of zero when method is invoked)
- D2
- D3
- D4
- P2

As long as a WR command is not issued, these configuration values will revert back to previous values after a power on reset. If a WR command is issued while in SPI mode, these same parameters will be written to flash. After a reset, parameters that were forced and then written to flash become the mode of operation. If the UART is disabled and the SPI is enabled in the written configuration, then the module will come up in SPI mode without forcing it by holding DOUT low. If both the UART and the SPI are enabled at the time of reset, then output will go to the UART until the host sends the first input. If that first input comes on the SPI port, then all subsequent output will go to the SPI port and the UART will be disabled. If the first input comes on the UART, then all subsequent output will go to the UART and the SPI will be disabled.

When the slave select (SPI_nSSEL) signal is asserted by the master, SPI transmit data is driven to the output pin SPI_MISO, and SPI data is received from the input pin SPI_MOSI. The SPI_nSSEL pin has to be asserted to enable the transmit serializer to drive data to the output signal SPI_MISO. A falling edge on SPI_nSSEL causes the SPI_MISO line to be tri-stated such that another slave device can drive it, if so desired.

If the output buffer is empty, the SPI serializer transmits the last valid bit repeatedly, which may be either high or low. Otherwise, the module formats all output in API mode 1 format, as described in chapter 7. The attached host is expected to ignore all data that is not part of a formatted API frame.

Serial Buffers

The XBee modules maintain buffers to collect received serial and RF data, which is illustrated in the figure below. The serial receive buffer collects incoming serial characters and holds them until they can be processed. The serial transmit buffer collects data that is received via the RF link that will be transmitted out the UART or SPI port.

Internal Data Flow Diagram

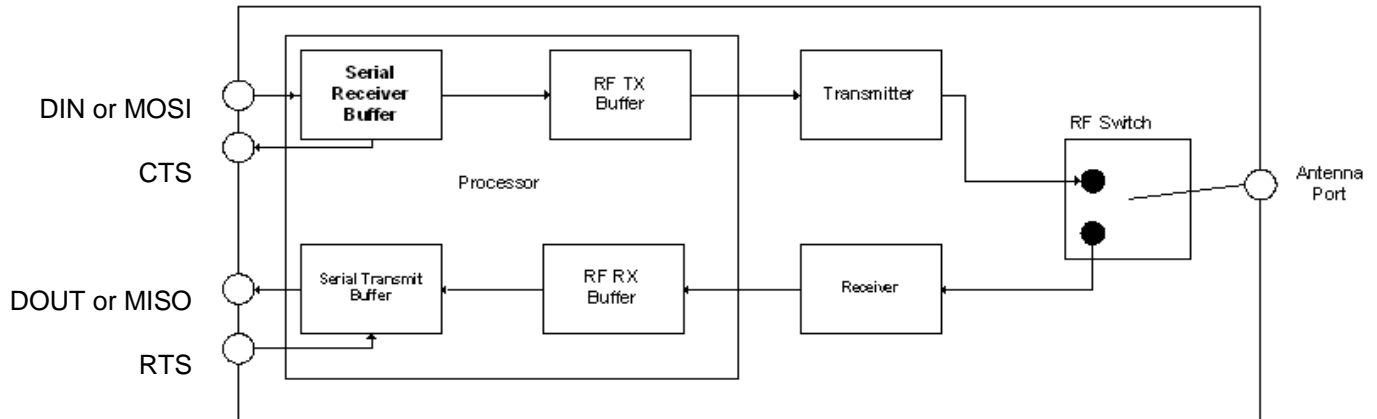

Serial Receive Buffer

When serial data enters the RF module through the DIN Pin (or the MOSI pin), the data is stored in the serial receive buffer until it can be processed. Under certain conditions, the module may not be able to process data in the serial receive buffer immediately. If large amounts of serial data are sent to the module such that the serial receive buffer would overflow, then the new data will be discarded. If the UART is in use, this can be avoided by the host side honoring CTS flow control.

Serial Transmit Buffer

When RF data is received, the data is moved into the serial transmit buffer and sent out the UART or SPI port. If the serial transmit buffer becomes full and system buffers are also full, then the entire RF data packet is dropped. Whenever data is received faster than it can be processed and transmitted out the serial port, there is a potential of dropping data, even in TCP mode.

UART Flow Control

The nRTS and nCTS module pins can be used to provide RTS and/or CTS flow control. CTS flow control provides an indication to the host to stop sending serial data to the module. RTS flow control allows the host to signal the module to not send data in the serial transmit buffer out the UAR. RTS and CTS flow control are enabled using the D6 and D7 commands.

nCTS Flow Control

The FT command allows the user to specify how many bytes of data can be queued up in the serial transmit buffer before the module asserts CTS low. The serial receive buffer can hold up to 2100 bytes, but FT cannot be set any larger than 2083 bytes, leaving 17 bytes that can be sent by the host before the data is dropped.

By default, FT is 2035 (0x7F3), which allows the host to send 65 bytes to the module after the module asserts CTS before the data is dropped.

In either case, CTS will not be re-asserted until the serial receive buffer has FT-17 or less bytes in use.

nRTS Flow Control

If RTS flow control is enabled (D6 command), data in the serial transmit buffer will not be sent out the DOUT pin as long as nRTS is de-asserted (set high). The host device should not de-assert nRTS for long periods of time to avoid filling the serial transmit buffer. If an RF data packet is received, and the serial transmit buffer does not have enough space for all of the data bytes, the entire RF data packet will be discarded.

Note: If RTS flow control is enabled and the XBee is sending data out the UART when nRTS is de-asserted (set high), the XBee could send up to 4 characters out the UART to clear its FIFO after nRTS is de-asserted. This implies that the user needs to de-assert nRTS by the time its receive capacity is within 4 bytes of full.

Serial Interface Protocols

The XBee modules support both transparent and API (Application Programming Interface) serial interfaces.

Transparent Operation

When operating in transparent mode, the modules act as a serial line replacement. All UART data received is queued up for RF transmission. When RF data is received, the data is sent out through the UART. The module configuration parameters are configured using the AT command mode interface. Please note that transparent operation is not an option when using SPI.

Data is buffered in the serial receive buffer until one of the following causes the data to be packetized and transmitted:

- No serial characters are received for the amount of time determined by the RO parameter. If RO is zero, data is packetized as soon as it is received, without delay. If RO is non-zero, the data is packetized after RO character times of no transitions on the DIN pin. However, if the time required for RO characters is less than 100 microseconds, then DIN must still be idle for at least 100 microseconds, which is the minimal idle time required for packetizing packets at any baud rate.
- The Command Mode Sequence (GT + CC + GT) is received. Any character buffered in the serial receive buffer before the sequence is packetized and transmitted before command mode is entered.
- The maximum number of characters that will fit in an RF packet is received.

API Operation

API operation is an alternative to transparent operation. The frame-based API extends the level to which a host application can interact with the networking capabilities of the module. When in API mode, all data entering and leaving the UART or SPI is contained in frames that define operations or events within the module.

Transmit Data Frames (received through the DIN pin (pin 3) or SPI_MOSI (pin 11)) include:

- RF Transmit Data Frame
- Local commands (equivalent to AT commands)
- Remote commands to be sent to another radio

Receive Data Frames (sent out the DOUT pin (pin 2) or SPI_MISO (pin 4)) include:

- RF-received data frames
- Local command responses
- Remote command responses
- I/O samples from a remote radio
- Event notifications such as transmission status, reset, associate, disassociate, etc.

The API provides an alternative means of configuring modules and of routing data at the local host application layer. A local host application can send data frames to the module that contain address and payload information instead of using command mode to modify addresses. The module will send data frames to the application containing status packets; as well as source, and payload information from received data packets. The API operation option facilitates many operations such as the examples cited below:

- Transmitting data to multiple destinations without entering Command Mode
- Receive success/failure status of each transmitted RF packet
- Identify the source address of each received packet

A Comparison of Transparent and API Operation

The following table compares the advantages of transparent and API modes of operation:

Transparent Operation Features	
Simple Interface	All received serial data is transmitted unless the module is in command mode.
Easy to support	It is easier for an application to support transparent operation and command mode.
API Operation Features	
Easy to manage data transmissions to multiple destinations	Transmitting RF data to multiple remotes only requires changing the address in the API frame. This Process is much faster than transparent operation where the application must enter AT command mode, change the address, exit command mode, and then transmit data. Each API transmission can return a transmit status frame indicating the success or reason for failure
Received data frames indicate the sender's address	All received RF data API frames indicate the source address.
Advanced Networking diagnostics	API frames can provide indication of IO samples from remote devices, transmission status messages, and local radio status messages.
Remote Configuration	Set/read configuration commands can be sent to remote devices to configure them as needed using the API.

As a general rule of thumb, API firmware is recommended when a device:

- sends RF data to multiple destinations
- sends remote configuration commands to manage devices in the network
- receives IO samples from remote devices
- receives RF data packets from multiple devices, and the application needs to know which device sent which packet

If the above conditions do not apply, (e.g. in a sensor node, or a simple application) then transparent operation might be suitable. It is acceptable to use a mixture of devices running API mode and transparent mode in a network.

Modes of Operation

Idle Mode

When not receiving or transmitting data, the RF module is in Idle Mode. The module shifts into the other modes of operation under the following conditions:

- Transmit Mode (Serial data in the serial receive buffer is ready to be packetized)
- Receive Mode (Valid RF data is received through the antenna)
- Sleep Mode
- Command Mode (Command Mode Sequence is issued)

Transmit Mode

When serial data is received and is ready to be packetized, the RF module will exit Idle Mode and attempt to transmit the data. The destination address determines which node(s) will receive the data.

Receive Mode

If a valid RF packet is received, the data is transferred to the serial transmit buffer.

Command Mode

To modify or read RF Module parameters, the module must first enter into Command Mode - a state in which incoming serial characters are interpreted as commands. Refer to the API Operation chapter for an alternate means of configuring modules, which is the only method available for SPI mode. (Command mode is unavailable when using the SPI interface.)

AT Command Mode

To Enter AT Command Mode:

Send the 3-character command sequence “+++” and observe guard times before and after the command characters. [Refer to the “Default AT Command Mode Sequence” below.]

Default AT Command Mode Sequence (for transition to Command Mode):

- No characters sent for one second [GT (Guard Times) parameter = 0x3E8]
- Input three plus characters (“+++”) within one second [CC (Command Sequence Character) parameter = 0x2B.]
- No characters sent for one second [GT (Guard Times) parameter = 0x3E8]

Once the AT command mode sequence has been issued, the module sends an "OK\r" out the UART. The "OK\r" characters can be delayed if the module has not finished transmitting received serial data.

When command mode has been entered, the command mode timer is started (CT command), and the module is able to receive AT commands on the UART.

All of the parameter values in the sequence can be modified to reflect user preferences.

NOTE: Failure to enter AT Command Mode is most commonly due to baud rate mismatch. By default, the BD (Baud Rate) parameter = 3 (9600 bps).

To Send AT Commands, send AT commands and parameters using the syntax shown below:

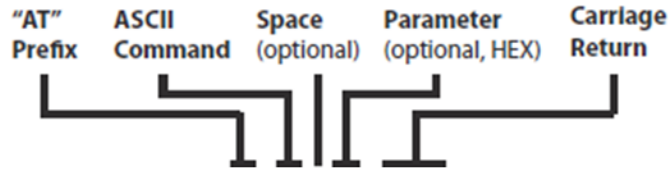

Example ATBD 7<CR>

To read a parameter value stored in the RF module's register, omit the parameter field.

The preceding example would change the RF module baud rate to 7, which would allow operation at 115,200bps. To store the new value to non-volatile (long term) memory, subsequently send the WR (Write) command.

For modified parameter values to persist in the module's registry after a reset, changes must be saved to non-volatile memory using the WR (Write) Command. Otherwise, parameters are restored to previously saved values after the module is reset.

Command Response

When a command is sent to the module, the module will parse and execute the command. Upon successful execution of a command, the module returns an "OK" message. If execution of a command results in an error, the module returns an "ERROR" message.

Applying Command Changes

Any changes made to the configuration command registers through AT commands will not take effect until the changes are applied. For example, sending the BD command to change the baud rate will not change the actual baud rate until changes are applied. Changes can be applied in one of the following ways:

- The AC (Apply Changes) command is issued.
- AT command mode is exited.

To Exit AT Command Mode:

1. Send the ATCN (Exit Command Mode) command (followed by a carriage return).
[OR]
2. If no valid AT Commands are received within the time specified by CT (Command Mode Timeout) Command, the RF module automatically returns to Idle Mode.

For an example of programming the RF module using AT Commands and descriptions of each configurable parameter, please see the Command Reference Table chapter.

Sleep Mode

Sleep modes allow the RF module to enter states of low power consumption when not in use. The XBee Wi-Fi modules support both pin sleep (sleep mode entered on pin transition) and cyclic sleep (module sleeps for a fixed time). XBee sleep modes are discussed in detail in chapter 5.

3. 802.11 bgn Networks

Infrastructure Networks

The main type of wireless network will involve a number of wireless devices (called stations) talking through a master wireless device known as an **Access Point** (AP for short). This type of setup is called an **Infrastructure or BSS** (Basic Service Set) network. Most wireless networks are of this type. An example of an infrastructure wireless network is shown below:

Infrastructure Wireless Network

Ad Hoc Networks

Wireless devices can get on a wireless network without an access point. This is called an **Ad Hoc or IBSS** (Independent Basic Service Set) network. An example of an ad hoc wireless network is shown below:

Ad-Hoc Networks



Note that ad hoc networks are point to point and that there can only be two nodes in the network, a creator and a joiner. Set up the creator first, and then the joiner.

Ad Hoc Creator

Set up the following parameters for the creator:

- AH1 designates the node as an Ad hoc creator.
- MA1 specifies static IP addresses. (No DHCP is supported in Ad Hoc mode.)
- EE0 specifies no security. (Security is not available in Ad Hoc mode.)
- CH May be any channel from 1 to 0x0E.
- BR May be any data rate from 1 to 0x14.
- ID Sets the SSID, which is any string of choice, as long as it isn't the same as another SSID in the vicinity.
- MY Sets IP address of creator node.
- DL Specifies IP address of joiner node.
- MK Sets IP mask for both of the above addresses.

Ad Hoc Joiner

Set up the following parameters for the joiner:

- AH0 designates the node as an Ad hoc joiner.
- MA1 Specifies static IP addresses. (No DHCP is supported in Ad Hoc mode.)
- EE0 specifies no security. (Security is not available in Ad Hoc mode.)
- ID Sets the SSID, which must match the ID of the creator. Problems arise if it matches the SSID of an access point in the vicinity.
- MY Sets IP address of joiner node.
- DL Specifies IP address of creator node.
- MK Sets IP mask for both of the above addresses.

Network Basics

Clients will need to join the wireless network before they can send data across it. This is called Association. In order for a device to associate it must know the following items about the desired wireless network:

- **SSID:** the name of the wireless network.
- **Encryption:** if and how the network encrypts or scrambles its data.
- **Authentication:** how and if the network requires its members to —prove their identity.
- **Channel:** what channel (frequency range) the wireless network uses.

Once a device is associated it can send and receive data from other associated devices on the same network. When the client is done or needs to leave, it then can Dis-associate and be removed from the wireless network.

XBee® Wi-Fi Standards

The XBee Wi-Fi module will operate in three of the available 802.11 standards.

802.11 b

The 802.11b standard was approved in July 1999 and can be considered the second generation. 802.11b operates in the 2.4 GHz frequency ISM band. The data rate is from 1 to 11 Mbps.

802.11 g

The 802.11g standard was approved in 2003. It provides a maximum data rate of 54 Mbps. In addition, the standard is also fully backwards-compatible with existing 802.11b wireless networks.

802.11 n

The 802.11n standard was approved in 2009. It provides for data rates up to 300Mbps. The XBee® Wi-Fi module uses the single stream n mode with 20MHz bandwidth and is capable of 65 Mbps over the air in n mode.

Encryption

Encryption is a method of scrambling a message that makes it unreadable to unwanted parties, adding a degree of secure communications. There are different protocols for providing encryption, and the XBee Wi-Fi module supports WPA and WPA2.

Authentication

Authentication deals with proving the identity of the wireless device attempting to associate with the network. There are different methods of doing this. The XBee Wi-Fi module supports Open and Shared Key.

Open

Open Authentication is when the access point simply accepts the wireless devices identify without verifying or proving it. The benefits to this is simplicity and compatibility (all devices can do it).

Shared Key

Shared Key is when the wireless devices must present the proper key to get on the network. Although Shared Key has more security than Open Authentication it should not be considered secure. One of the benefits of Shared Key Authentication is simplicity.

Channels

The XBee® Wi-Fi modules operate in the 2.412-2.484 MHz range. The frequency range is broken down into 14 channels. Data is transmitted on a channel by radio frequencies over a certain frequency range. In order to avoid bad performance caused by the overlapping (“collision”) of channel frequencies in a wireless LAN environment, it is very important that the channels of neighboring access points are selected accordingly.

The center frequencies of the 14 possible channels range from 2.412 GHz to 2.484 GHz, with each channel being 22 MHz wide and centered in 5 MHz intervals. This means that only 3 channels (1, 6, and 11) in North America are not subject to overlapping.

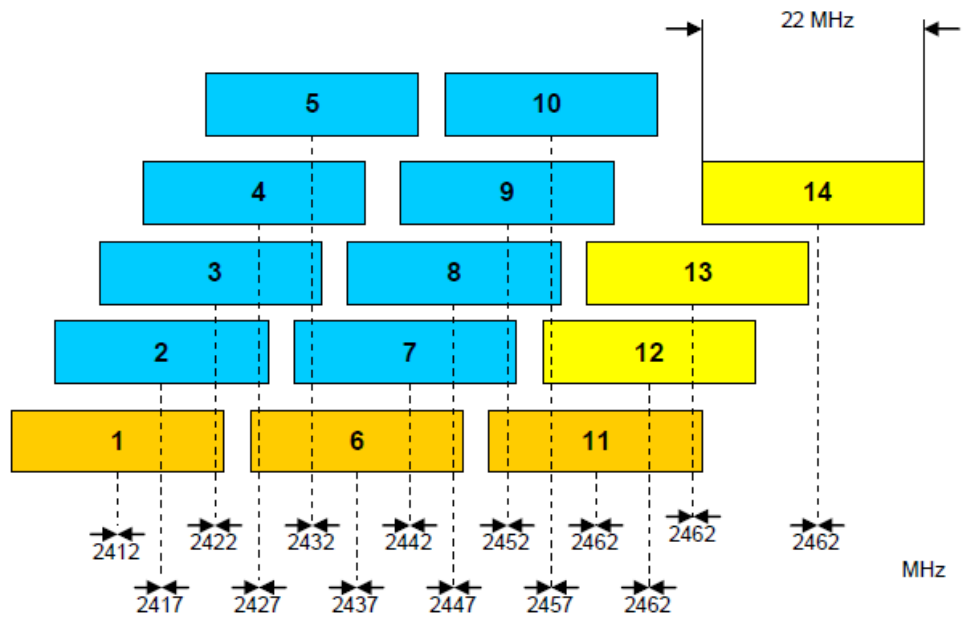

4. XBee IP Services

The XBee provides services using IP (Internet Protocol) for XBee and other clients on the network. IP services provide functionality to allow XBee configuration and direct serial port access. There are two XBee services:

- XBee Application Service
- Serial Communication Service

XBee Application Service

This service primarily provides for XBee configuration. It also provides API compatibility for customers who have designed around other XBees. It uses UDP to transfer packets on port number 0xBEE. Packets are optionally acknowledged by the service but retries are not available. An extra header is added to the packet data to define commands for configuration and serial data transfer. The following sections describe how this service can be accessed from a local host or network client.

Local Host

From a local host this functionality is accessed through XBee API frames. There are remote AT command frames as well as transmission frames. The API frames are listed as follows:

- TX request: 64-bit (TX64)
- RX indicator: 64-bit (RX64)(This frame is generated by the XBee module.)
- Remote AT command

TX64 and RX64 API frames

The intent of the XBee transmit and receive 64-bit API frames is to provide a standardized set of API frames to use for a point to multipoint network—a closed network of XBee Wi-Fi modules. These frames are compatible with the XBee 802.15.4 module.

Transmitting data

The local host uses the TX64 frame to send data to another XBee using this service. When the frame is received through the serial port the XBee converts the contents of the frame to a serial data transfer command as defined by the XBee application service.

Receiving data

A received Serial data transfer command will go to the serial port. The mode of the serial port will determine the format of the data. When in API mode the data will be sent to the host using the RX 64-bit frame.

Note: It is not recommended to use this service to send data to a network client. Use the serial communication service.

Remote AT command configuration

The Remote AT command frame is used to change configuration on a remote Xbee. See Remote AT command frame in the API Operation chapter for more information.

Network Client

This port is accessed by sending a packet from the client using the UDP protocol on port 0xBEE. Data sent to this port must have an additional header preceding the data. The header description follows:

Field Name	Offset	Description
Command ID	0	Serial Data:0x0 Remote AT command:0x2 Application acknowledgements are not supported Serial Data Acknowledgement: 0x80 Sent in response to option bit 1 sent for the Serial Data command Serial Data Acknowledgement: 0x80 Remote AT command response:0x82
Command options	1	

Sending configuration commands

AT commands can be sent to the XBee Wi-Fi module from a network client. The following packet structure must used to send the command.

	Packet Fields	Offset	Example	Description	
Client Packet Data	Command ID	0	0x02		
	Command options	1	0	Options are not available for this command	
	Command Specific Data	Frame ID	2	0x01	This is provided for application support and is not used by the XBee. The value will be sent back as part of the response packet.
		Configuration options	3	0x02	0 – Queue command parameter. Must send AC command or use option 2 to apply changes. 2 – Apply changes to all changed commands
		AT Command	MSB 4 LSB 5	0x49 (I) 0x44(D)	Command Name - Two ASCII characters that identify the AT command
	Parameter Value			If present, indicates the requested parameter value to set the given command. If no characters present, command is queried.	

The response will be sent back to the host with the following bytes.

	Packet Fields		Offset	Example	Description	
Client Packet Data	Command ID		0	0x82		
	Command Options		1	0x00	Options not available for this response	
	Command Specific Data	Frame ID		3	0x01	Copied from the command
		Configuration command options		3	0x88	Options not available for this response
		AT Command		MSB 5	0x49 (I)	Command Name - Two ASCII characters that identify the AT command
				LSB 6	0x44 (D)	
	Status			0x00	0 = OK 1 = ERROR 2 = Invalid Command 3 = Invalid Parameter	
Parameter Value		7	The first byte of the ID value would start here	Register data in binary or ASCII format, based on the command. For the ID command, the data is in ASCII format. If the command was set, then this field is not returned.		

Sending serial data command to XBee

Using this service to send data out the serial port is not required. Most users will choose to use the Serial Communication Service (see below) for sending data from a network client. One reason to use the XBee Application Service to send the serial data command from a network client is to receive an acknowledgment when sending a UDP packet.

The client can request an acknowledgement from the XBee but must wait to receive the acknowledgement before sending the next packet. The client is responsible for retransmissions due to missed acknowledgments. When resending packets, duplicates can be received at the destination due to a successful serial data command and a failed acknowledgment packet. The host in this case must be able to handle duplicate packets.

Serial Data Command:

	Packet Fields		Offset	Example	Description
Client Packet data	Command ID		0	0	
	Command Options		1	0x2	bit 1 - Request acknowledgment be sent.
	Command Specific Data	Serial Data	3	0x01	Can be up to 1400 bytes. Data will be sent out the XBee's serial port.

Serial Data command acknowledgment if requested:

	Packet Fields	Offset	Example	Description
Client Packet Data	Command ID	0	0x80	
	Command Options	1	0x0	Options not available for this response
	Command Specific Data			No command specific data

Receiving I/O sampled data

Sample data generated by the module will be sent to the address configured by the DL commands. This data can be sent to either XBee or a network client. It will be sent using UDP on the 0xBEE port as with other XBee Application services. Sample data will be received by the client as follows:

	Frame Fields	Offset	Example	Description	
X B e e P a c k e t D a t a	Command ID	0	0x04		
	Command Options	1	0x00	Options not available for this response	
	Command Specific Data	Number Samples	3	0x01	Will be set to one. DIO and ADC considered a sample. At least one DIO or ADC must be enabled to get this packet type.
		Digital Mask	MSB 4	0x00	Bit Mask. Each bit represents an enabled DIO I/O line starting with DIO0 at bit 0.
			LSB 5	0x01	
		Analog Mask	6	0x02	Bit Mask. Each bit represents an enabled ADC starting with ADC0 at bit 0.
		Digital Sample	MSB 7	0x00	This field is only present if at least one DIO I/O is enabled. Use the digital mask to determine if sample is present. Each bit represents a DIO line start with bit 0 for DIO0.
	LSB 8		0x01		
	Analog Sample	MSB 9	0x01	Analog Samples start here and will be in order as indicated in the Analog Mask. Only those lines enabled will be sent. In the example this sample is for AD1.	
		LSB 10	0x00		

Serial Communication Service

A client or XBee can send data directly to the serial port using this service. No additional header or formatting is required. The port is configured using the C0 command. The behavior of this service varies based on the mode of the serial port and is discussed in the following sections.

Transparent mode

Only one port is available and can be either UDP or TCP. It is configured through the IP command. Data received by the service is sent to the serial port without any additional processing.

UDP

When the IP command is configured for UDP, data received on the serial port will be packetized and sent to the IP address specified by the DL command and to the destination port specified by the DE command. The source port is defined by the C0 command.

TCP

TCP provides for a connection based protocol. When in transparent mode the module will only allow one connection at a time. A connection can be initiated by a local host or by a network client.

A local host initiates a connection by sending data to the serial port. A connection will be created based on the DL (IP address) and DE (destination port) commands.

A network client establishing a TCP connection to the XBee will use the port defined by the C0 command. When established any data sent by the local host will not create a new connection based on DL and DE, but rather the existing connection will be utilized.

API mode

Because API mode has more capabilities both UDP and TCP are supported at the same time. The local host will utilize the TX IPv4 transmit frame to send data from the module and will receive data through the RX IPv4 received frame. These frames give greater IP control and visibility to the local host. See the API section for more information.

5. Sleep

The XBee Wi-Fi module supports two different sleep modes.

- Pin Sleep
- Cyclic Sleep

In addition the sleep mode current draw can be modified with the following sleep options.

- AP Associated Sleep
- Deep Sleep

Pin sleep allows an external microcontroller to determine when the XBee should sleep and when it should wake by controlling the Sleep_RQ pin when using the UART or SPI_nSSEL when using SPI. In contrast, cyclic sleep allows the sleep period and wake times to be configured through the use of AT commands or through the DTIM setting on the access point (associated sleep). The module can stay associated to the access point or can enter a deeper sleep and associate to the access point for each sleep/wake occurrence. The sleep mode is configurable with the SM and SO commands.

Besides the four sleep modes mentioned above, each of them operate a little differently based on the serial interface (UART or SPI).

Sleeping with the UART

When the serial interface is UART, the On/nSleep pin is used to indicate that the module is entering sleep mode, unless pin 13 is configured for a different usage. (See command reference table) If D9 is configured for On/nSleep, then it is driven low when asleep and high when awake, whether using pin sleep or cyclic sleep.

If CTS hardware flow control is enabled (D7 command), the CTS pin (pin 12) is de-asserted (high) when entering sleep to indicate that serial data should not be sent to the module. The module will not respond to serial or RF data when it is sleeping. Applications that utilize the UART are encouraged to observe CTS flow control in any of the sleep modes. When the XBee wakes from sleep with flow control enabled, the CTS pin is asserted (low).

If using pin sleep, D8 (mapped to XBee pin 9) must be configured for SleepRq (See command reference table) to put the module to sleep. Otherwise, there is no sleep at all, meaning the module will always stay awake in full power mode. When D8 is configured for SleepRq, the host should drive pin 9 high to put the module to sleep, and the host should drive pin 9 low to wake up the module.

Sleeping with the SPI

When the serial interface is SPI, pin 19 is used as an attention indicator to tell the SPI master when it has data to send. Since SPI only operates in API mode, it will assert SPI/nATTN and send out a modem status indicator after initialization. The host can use this to know when the radio is ready to operate as a SPI slave. Since the function of pin

19 is to indicate when the XBee has data to send to the host, it may legitimately be driven high or low while the module is awake.

SPI_nSSEL (pin 17) is the equivalent of SleepRq for the SPI interface. The SPI master drives pin 17 low not only to indicate that the XBee is selected as the active slave, but also to indicate that the XBee should wake up. When the SPI master drives pin 17 high, that gives the XBee license to go back to sleep, which it will do after data is clocked out.

Sleep Options

AP Associated sleep

This option allows the module to sync up with beacons sent from the AP which contains the DTIM (Delivery Traffic Indication Message). The DTIM indicates when broadcast and multicast data will be sent on the network. This property is configured on the AP and is typically configured as the number of beacons between each beacon with DTIM.

The sleep modes are described as follows with this option enabled.

Pin sleep mode

The module remains associated to the AP and will wake based on the period of the DTIM. This wake period will not be seen by the local host unless data has been sent to the module. In this case the module will 'wake' by asserting the appropriate I/O lines. The local UART host is then required to de-assert SleepRq to awaken the module. Note that the module will be drawing more current when waiting for the host to de-assert SleepRq. Once SleepRq is de-asserted the module will then send the data to the host.

SPI operation is similar except that the radio asserts nATTN when data becomes available and then the local host is expected to assert SPI_nSSEL and to provide a clock until the data available is sent out.

When the local UART host needs to send data it de-asserts SleepRq. Once the appropriate status I/O lines are asserted (CTS and/or On/nSleep) the module is ready to accept data. However data will be queued and not sent until the next DTIM.

When the local SPI host needs to send data it asserts SPI_nSSEL. This wakes up the module, which will then accept the incoming data. However data will be queued and not sent until the next DTIM.

Cyclic sleep mode

The module remains associated to the AP and will sleep based on the period of the DTIM. After DTIM, the module will awaken for 30 milliseconds to check for data from the AP and to allow the host to send data or commands. This time is factored in as part of the overall ST time. When data is received or sent then the module will remain awake for ST time and any further activity will not restart this time. The module will draw the RX current during the wake period.

Deep sleep (non-associated sleep)

This option allows the Wi-Fi circuitry to be powered down resulting in the lowest sleep current but at the expense of longer wake up times. This is due to the module associating with the access point every time it wakes up. The intent of this option is to allow for very long sleep times.

Pin sleep mode

In this mode when SleepRq _RQ is asserted the module will power down the Wi-Fi circuitry. When SleepRq is de-asserted the Wi-Fi circuitry is powered up. This causes the module to associate to the access point for each wake event. The module could take many seconds to complete the association and longer if DHCP is used.

Cyclic sleep mode

In this mode the module will enter and exit sleep based on the SP and ST commands. The module will control power to the Wi-Fi circuitry as it cycles through sleep and wake. This causes the module to associate to the access point for each wake event. The module could take many seconds to complete the association and longer if DHCP is used. However to control battery usage, ST specifies and limits the wake time. If ST expires before association is successful, sleeping is resumed without ever associating. It is the user's responsibility to configure ST as needed. Also, the user should wait for association after waking up before sending data. When data is sent by the local host then the module will remain awake for ST time and any further activity will not restart this time. The module will draw RX current during the wake period.

Sampling data using sleep modes

Data can be sampled when waking from any sleep mode by enabling an ADC or digital input and setting IR appropriately with respect to ST to obtain the desired number of samples.

Sample Rate (ATIR)

If multiple samples are wanted during the wake period then IR can be used. This will provide ST/IR+1 samples. Each sample will be sent separately.

Wake Host

Wake host parameter (ATWH) delays UART and sample data from being initiated until the timer has expired. This allows the host to wake up before receiving data or a sensor to power up before an I/O sample is taken.

Digital outputs and special function outputs such as ON_SLEEP and CTS are not affected by WH. This is to allow these signals to be used to wake up devices.

Note that for deep sleep, both WH must be expired and the module must be associated before I/O samples are taken.

6. XBee Analog and Digital IO Lines

XBee Wi-Fi firmware supports a number of analog and digital IO pins that are configured through software commands. Analog and digital IO lines can be set or queried. The following table lists the configurable IO pins and the corresponding configuration commands.

Pin name(s)	Module pin	AT cmd	Command Range
DIO12/SPI_MISO	4	P2	0,1,3-5
DIO10/PWM0	6	P0	0,2-5
DIO11/PWM1	7	P1	0,2-5
DIO8/nDTR/SLEEP_RQ	9	D8	0,1,3-5
DIO4/AD4/SPI_MOSI	11	D4	0-5
DIO7/nCTS	12	D7	0,1,3-7
DIO9/ON_nSLEEP	13	D9	0,1,3-5
DIO5/ASSOCIATE	15	D5	0,1,3-5
DIO6/nRTS	16	D6	0,1,3-5
DIO3/AD3/SPI_nSSEL	17	D3	0-5
DIO2/AD2/SPI_CLK	18	D2	0-5
DIO1/AD1/SPI_nATTN	19	D1	0-5
DIO0/AD0	20	D0	0,2-5

IO Configuration

To enable an analog or digital IO function on one or more XBee module pin(s), the appropriate configuration command must be issued with the correct parameter. After issuing the configuration command, changes must be applied on the module for the IO settings to take effect. Pull-up/down resistors can be set for each digital input line using the PR command. The PR value updates the state of all pull-up/down resistors, and the PD command determines if a pull-up or pull-down is used. See Chapter 8 for information on these commands

Pin Command Parameter	Description
0	Disabled
1	Peripheral control
2	Analog input or PWM output
3	Data in monitored
4	Data out default low
5	Data out default High
6	RS485 enable low
7	RS485 enable high
>7	Unsupported

IO Sampling

The XBee ZB modules have the ability to monitor and sample the analog and digital IO lines. IO samples can be read locally or transmitted to a remote device to provide indication of the current IO line states. (Only API firmware devices can send remote IO sample data out their UART or SPI ports.)

There are three ways to obtain IO samples, either locally or remotely:

- Queried Sampling
- Periodic Sampling
- Change Detection Sampling.

IO sample data is formatted as shown in the table below

Bytes	Name	Description
1	Sample Sets	Number of sample sets in the packet. (Always set to 1.)
2	Digital Channel mask	<p>Digital IO line on the module.</p> <ul style="list-style-type: none"> • bit 0 = DIO0 • bit 1 = DIO1 • bit 2 = DIO2 • bit 3 = DIO3 • bit 4 = DIO4 • bit 5 = DIO5 • bit 6 = DIO6 • bit 7 = DIO7 • bit 8 = DIO8 • bit 9 = DIO9 • bit 10 = DIO10 • bit 11 = DIO11 • bit 12 = DIO12 <p>For example, a digital channel mask of 0x002F means DIO0 1, 2, 3, and 5 are enabled as digital IO.</p>
1	Analog Channel Mask	<p>Indicates which lines have analog inputs enabled for sampling. Each bit in the analog channel mask corresponds to one analog input channel.</p> <ul style="list-style-type: none"> • bit 0 = AD0 • bit 1 = AD1 • bit 2 = AD2 • bit 3 = AD3 • bit 4 = AD4
Variable	Sampled Data Set	<p>If any digital IO lines are enabled, the first two bytes of the data set indicate the state of all enabled digital IO. Only digital channels that are enabled in the Digital Channel Mask bytes have any meaning in the sample set. If no digital IO is enabled on the device, these 2 bytes will be omitted.</p> <p>Following the digital IO data (if any), each enabled analog channel will return 2 bytes. The data starts with AD0 and continues sequentially for each enabled analog input channel up to AD4.</p>

The sampled data set will include 2 bytes of digital IO data only if one or more IO lines on the device are configured as digital IO. If no pins are configured as digital IO, these 2 bytes will be omitted.

The digital IO data is only relevant if the same bit is enabled in the digital IO mask. Analog samples are 10 bit values and aligned on a 16 bit boundary. The analog reading is scaled such that 0x0000 represents 0V, and 0x3FF = VREF. VREF may be either 1.25 volts or 2.5 volts based on the setting of the AV command, where 2.5 volts is the default. The analog inputs on the module are capped at 0x3FF. Analog samples are returned in order starting with AD0 and finishing with AD4. Only enabled analog input channels return data as shown in the example below.

To convert the A/D reading to mV, do the following:

$$\text{AD (mV)} = (\text{A/D reading (converted to decimal)} * \text{VREF}) / 1023 \text{ where VREF may be 1250 or 2500}$$

Assuming that AV is set to the default value, the reading in the sample frame represents voltage inputs of 2385.14 mV (0x3D0) and 713.59 mV (0x124) for AD0 and AD1 respectively.

Queried Sampling

The IS command can be sent to a device locally, or to a remote device using the API remote command frame (see chapter 8 for details). When the IS command is sent and at least one IO line is enabled as an input or an output, the receiving device samples all enabled digital IO and analog input channels and returns an IO sample. When no IO line is enabled, IS will return nothing. If IS is sent locally, the IO sample is sent out the UART or SPI port. If the IS command was received as a remote command, the IO sample is sent over-the-air to the device that sent the IS command.

If the IS command is issued in command mode, the module returns a carriage return-delimited list containing the above-listed fields. If the IS command is issued in API mode, the module returns an API command response packet with the IO data included in the command data portion of the response frame.

The following table shows an example of the fields in an IS response.

Example	Sample AT Response
0x01	[1 sample set]
0x0C0C	[Digital Inputs: DIO 2, 3, 10, 11 selected]
0x03	[Analog Inputs; A/D 0,1]
0x0408	[Digital input states: DIO 3,10 high, DIO 2,11 low]
0x03D0	[Analog input ADIO 0=0x3D0]
0x0124	[Analog input ADIO 1=0x120]

Periodic IO Sampling

Periodic sampling allows the XBee module to take an IO sample and transmit it to a remote device at a periodic rate. The periodic sample rate is set by the IR command. If IR is set to 0 or there are no active IO lines, periodic sampling is disabled. For all other values of IR, data will be sampled after IR milliseconds have elapsed and transmitted to a remote device. The DL command determines the destination address of the IO samples. DL can be set to transmit to a network client or another XBee Wi-Fi module. Only modules with API mode enabled for the serial port can send IO data samples out their serial port. Network clients will receive the IO data packet as described in the XBee IP Services chapter.

IR can be used with sleep. A module will transmit periodic IO samples at the IR rate until the ST timer expires, the SLEEP_RQ line is asserted, and the device can resume sleeping. Even if the IR rate is set longer than the ST defined wake time, at least one IO sample will still be sent before the module returns to sleep because it sends one immediately upon wake up. If it is not desired that a sample is sent every wake cycle, the IF command can be used to configure how many wake cycles should elapse before sending IO samples at the IR rate.

Change Detection Sampling

Modules can be configured to transmit a data sample immediately whenever a monitored digital IO pin changes state. The IC command is a bitmask that can be used to set which digital IO lines should be monitored for a state change. If one or more bits in IC is set, an IO sample will be transmitted as soon as a state change is observed in one of the monitored digital IO lines. Change detection samples are transmitted to the IPv4 address specified by DL.

I/O Examples

Example 1: Configure the following IO settings on the XBee

Configure AD1/DIO1 as a digital input with pull-up resistor enabled

Configure AD2/DIO2 as an analog input

Configure DIO4 as a digital output, driving high.

To configure AD1/DIO1 as an input, issue the ATD1 command with a parameter of 3 ("ATD13"). To enable pull-up resistors on the same pin, the PR command should be issued with bit 3 set (e.g. ATPR8, ATPR1FFF, etc.). The ATD2 command should be issued with a parameter of 2 to enable the analog input ("ATD22"). Finally, DIO4 can be set as an output, driving high by issuing the ATD4 command with a parameter value of 5 ("ATD45").

After issuing these commands, changes must be applied before the module IO pins will be updated to the new states. The AC or CN commands can be issued to apply changes (e.g. ATAC).

7. API Operation

As an alternative to Transparent Operation, API (Application Programming Interface) Operations are available. API operation requires that communication with the module be done through a structured interface (data is communicated in frames in a defined order). The API specifies how commands, command responses and module status messages are sent and received from the module using a UART or SPI Data Frame.

Please note that Digi may add new API frames to future versions of firmware, so please build into your software interface the ability to filter out additional API frames with unknown Frame Types.

API Frame Specifications

Two API modes are supported and both can be enabled using the AP (API Enable) command. Use the following AP parameter values to configure the module to operate in a particular mode:

- AP = 1: API Operation
- AP = 2: API Operation (with escaped characters)

API Operation (AP parameter = 1)

When this API mode is enabled (AP = 1), the UART or SPI data frame structure is defined as follows:

UART or SPI Data Frame Structure:

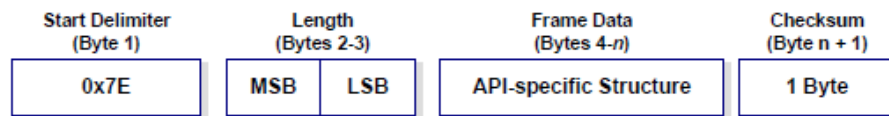

MSB = Most Significant Byte, LSB = Least Significant Byte

Any data received prior to the start delimiter is silently discarded. If the frame is not received correctly or if the checksum fails, the module will reply with a module status frame indicating the nature of the failure.

API Operation-with Escape Characters (AP parameter = 2)

When this API mode is enabled (AP = 2), SPI mode is not supported and the UART frame structure is defined as follows:

UART Data Frame Structure - with escape control characters:

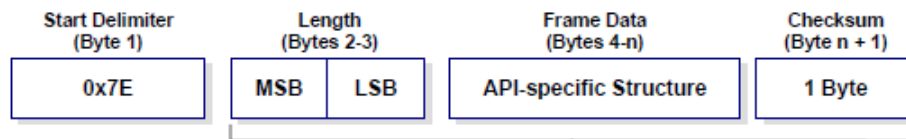

MSB = Most Significant Byte, LSB = Least Significant Byte

Escape characters

When sending or receiving a UART data frame, specific data values must be escaped (flagged) so they do not interfere with the data frame sequencing. To escape an

interfering data byte, insert 0x7D and follow it with the byte to be escaped XOR'd with 0x20.

Data bytes that need to be escaped:

- 0x7E – Frame Delimiter
- 0x7D – Escape
- 0x11 – XON
- 0x13 – XOFF

Example - Raw UART Data Frame (before escaping interfering bytes):

0x7E 0x00 0x02 0x23 0x11 0xCB

0x11 needs to be escaped which results in the following frame:

0x7E 0x00 0x02 0x23 0x7D 0x31 0xCB

Note: In the above example, the length of the raw data (excluding the checksum) is 0x0002 and the checksum of the non-escaped data (excluding frame delimiter and length) is calculated as: $0xFF - (0x23 + 0x11) = (0xFF - 0x34) = 0xCB$.

Length

The length field has a two-byte value that specifies the number of bytes that will be contained in the frame data field. It does not include the checksum field.

Framed Data

Frame data of the UART or SPI data frame forms an API-specific structure as follows:

UART or SPI Data Frame & API-specific Structure:

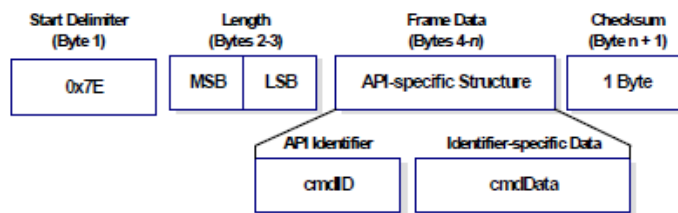

The cmdID frame (API-identifier) indicates which API messages will be contained in the cmdData frame (Identifier-specific data). Note that multi-byte values are sent big endian. The XBee modules support the following API frames:

API Frame Names and Values

API Frame Names	API ID
Tx64 Request	0x00
AT Command	0x08
AT Command - Queue Parameter Value	0x09
Remote Command Request	0x07
TX IPv4	0x20
Rx64 Indicator	0x80
AT Command Response	0x88
TX Status	0x89
Modem Status	0x8A
IO Data Sample Rx Indicator	0x8F
Remote Command Response	0x87
RX IPv4	0xB0

Checksum

To test data integrity, a checksum is calculated and verified on non-escaped data.

To calculate: Not including frame delimiters and length, add all bytes keeping only the lowest 8 bits of the result and subtract the result from 0xFF.

To verify: Add all bytes (include checksum, but not the delimiter and length). If the checksum is correct, the sum will equal 0xFF.

API Examples

Example: Create an API AT command frame to configure an Xbee baud rate to 230,400 (set BD to 0x08). The frame should look like (in hex):

7E 00 05 08 01 42 44 08 68

Where:

- 0x0005 = length excluding checksum
- 0x08 = AT Command API frame type
- 0x01 = Frame ID (set to non-zero value for transmit status)
- 0x4244 = AT Command ('BD')
- 0x08 = value to set command to
- 0x68 = Checksum

The checksum is calculated as $[0xFF - (0x08 + 0x01 + 0x42 + 0x44 + 0x08)]$

Example: Send a remote command to a module who's IP address is 192.168.0.103 (C0 A8 00 67) to set AD1/DIO1 as a digital input (D1=3) and apply changes to force the IO update. The API remote command frame should look like (in hex):

7E 00 0E 07 01 00 00 00 00 C0 A8 01 64 02 44 31 03 B0

Where:

- 0x000E = length (14 bytes excluding checksum)
- 0x07 = Remote Command API frame type
- 0x01 = Frame ID
- 0x00000000 C0A80067 = Remote address (Pad first 4 bytes with 00)
- 0x02 = Apply Changes (Remote Command Options)
- 0x4431 = AT command ('D1')

0xB0 = Checksum

API UART and SPI Exchanges

AT Commands

The following image shows the API frame exchange that takes place at the UART or SPI when sending an AT command request to read or set a module parameter. The response can be disabled by setting the frame ID to 0 in the request.

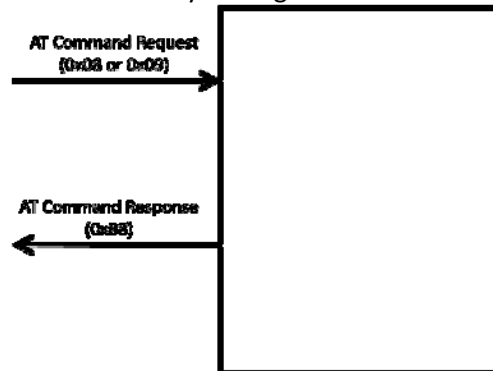

Transmitting and Receiving RF Data

The following image shows the API exchanges that take place at the UART or SPI when sending RF data to another device. The transmit status frame is always sent at the end of a data transmission unless the frame ID is set to 0 in the transmit request. If the packet cannot be delivered to the destination, the transmit status frame will indicate the cause of failure. The received data frame (0x80 or 0xB0) is set by the AP command.

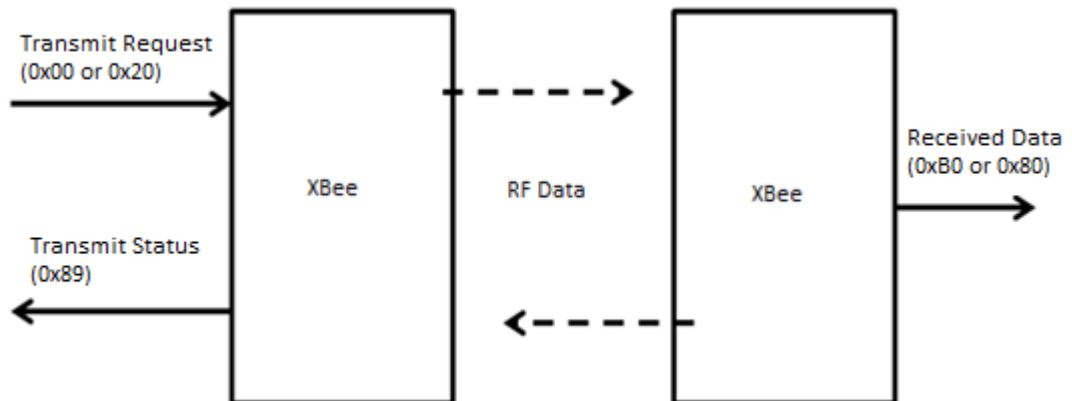

Remote AT commands

The following image shows the API frame exchanges that take place at the UART or SPI when sending a remote AT command. A remote command response frame is not sent out the UART or SPI if the remote device does not receive the remote command.

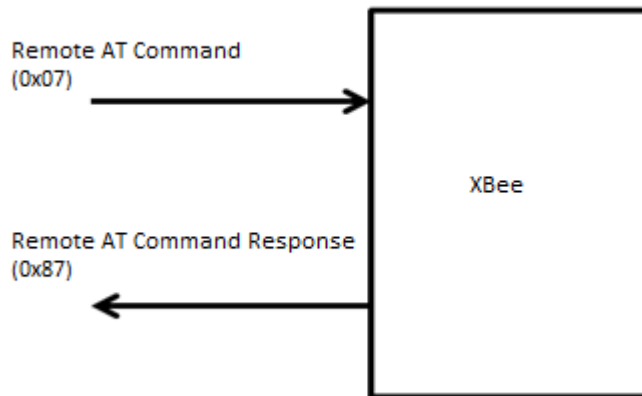

Supporting the API

Applications that support the API should make provisions to deal with new API frames that may be introduced in future releases. For example, a section of code on a host microprocessor that handles received serial API frames (sent out the module's DOUT pin) might look like this:

```
void XBee_HandleRxAPIFrame(_apiFrameUnion *papiFrame){
    switch(papiFrame->api_id){
    case RX_RF_DATA_FRAME:
        //process received RF data frame break;

    case RX_IO_SAMPLE_FRAME:
        //process IO sample frame break;

    default:
        //Discard any other API frame types that are not being used break;
    }
}
```

API Frames

The following sections illustrate the types of frames encountered while using the API.

TX (Transmit) request: 64-Bit

Frame Type: 0x0

This frame type uses the XBee Application Service. This command allows for software compatibility with other XBee module such as the 802.15.4 module.

	Frame Fields		Offset	Example	Description		
API Packet	Start Delimiter		0	0x7E			
	Length		MSB 1	0x00	Number of bytes between the length and the checksum		
			LSB 2	0x0D			
	API Frame Specific Data	API Frame Identifier		3	0x00		
		Frame ID		4	0x01		
		64-Bit Destination Address		5		0x00	Align IP address to low 32-bits of the field. The other bytes set to 0. IP address is in hex. The address in this example is 192.168.0.100
					0x00		
					0x00		
					0x00		
					0xC0		
			0xA8				
	0x00						
	0x64						
	TX Options		13	0x00	0x01 – Disable ACK All other bits must be set to 0.		
	Data		14	0x1516	Max is 1398 bytes. Data will be sent to the XBee application service port.		
	Checksum			0xD9	0xFF minus the 8 bit sum of bytes from offset 3 to this byte.		

AT Command

Frame Type: 0x08

Used to query or set module parameters on the local device. This API command applies changes after executing the command. (Changes made to module parameters take effect once changes are applied.) The API example below illustrates an API frame when modifying the NI parameter value of the module.

	Frame Fields		Offset	Example	Description	
API Packet	Start Delimiter		0	0x7E		
	Length		MSB 1	0x00	Number of bytes between the length and the checksum	
			LSB 2	0x05		
	API Frame Specific Data	API Frame Identifier		3	0x08	
		Frame ID		4	0x01	
		AT Command		MSB 5	0x4E(N)	Command Name - Two ASCII characters that identify the AT command
				LSB 6	0x49(I)	
	Parameter Value		-	-	If present, indicates the requested parameter value to set the given register. If no characters present, register is queried.	
Checksum		7	0x5E	0xFF minus the 8 bit sum of bytes from offset 3 to this byte.		

AT Command-Queue Parameter Value

Frame Type: 0x09

This API type allows module parameters to be queried or set. In contrast to the “AT Command” API type, new parameter values are queued and not applied until either the “AT Command” (0x08) API type or the AC (Apply Changes) command is issued. Register queries (reading parameter values) are returned immediately.

Example: Send a command to change the baud rate (BD) to 115200 baud, but don't apply changes yet. (Module will continue to operate at the previous baud rate until changes are applied.)

	Frame Fields		Offset	Example	Description	
API Packet	Start Delimiter		0	0x7E		
	Length		MSB 1	0x00	Number of bytes between the length and the checksum	
			LSB 2	0x05		
	API Frame Specific Data	API Frame Identifier		3	0x09	
		Frame ID		4	0x01	
		AT Command		MSB 5	0x42 (B)	Command Name - Two ASCII characters that identify the AT command
				LSB 6	0x44 (D)	
	Parameter Value		7	0x07	If present, indicates the requested parameter value to set the given register. If no characters present, register is queried.	
Checksum		8	0x68	0xFF minus the 8 bit sum of bytes from offset 3 to this byte.		

Note: In this example, the parameter could have been sent as a zero-padded 2-byte or 4-byte value.

Remote AT Command Request

Frame Type: 0x07

Used to query or set module parameters on a remote device. For parameter changes on the remote device to take effect, changes must be applied, either by setting the apply changes options bit, or by sending an AC command to the remote.

Example: Send a remote command to query the DL register on a remote device. In this example, the IP address of the remote is 192.168.0.100.

	Frame Fields	Offset	Example	Description
API Packet	Start Delimiter	0	0x7E	
	Length	MSB 1	0x00	Number of bytes between the length and the checksum
		LSB 2	0x0D	
	API Frame Identifier	3	0x07	
	Frame ID	4	0x01	
	64-Bit Destination Address	5	0x00	Align IP address to low 32-bits of the field. The other bytes set to 0. IP address is in hex. The address in this example is 192.168.0.100
		6	0x00	
		7	0x00	
		8	0x00	
		9	0xC0	
		10	0xA8	
		11	0x00	
	12	0x64		
Command Options	13	0x02	0x02 – Apply changes on the remote. If not set then the AC command must be sent or the last remote command sent must set this option.	
AT Command	MSB 14	0x44(D)	Command Name - Two ASCII characters that identify the AT command	
	LSB 15	0x4C(L)		
Parameter Value	-		If present, indicates the requested parameter value to set the given register. If no characters present, register is queried.	
Checksum		16	0x99	0xFF minus the 8 bit sum of bytes from offset 3 to this byte.

Transmit (TX) request: IPv4

Frame Type: 0x20

This frame type utilizes the serial data service. The frame gives greater control to the application over the IP setting for the data.

Frame Fields		Offset	Example	Description
API Packet	Start Delimiter	0	0x7E	
	Length	MSB 1	0x00	Number of bytes between the length and the checksum
		LSB 2	0x11	
	API Frame Identifier	3	0x20	
	Frame ID	4	0x01	Set to a value that will be passed back in the Tx Status frame. 0 disables the Tx Status frame.
	IPv4 32 bit Destination Address	MSB 5	0xC0	Use 0xFFFFFFFF for broadcast when protocol is UDP. The address in the example is for a destination of 192.168.0.100
		6	0xA8	
		7	0x00	
		8	0x64	
	16 Bit Destination Port	MSB 9	0x26	UDP or TCP port number
		LSB 10	0x16	
	16 bit Source Port	MSB 11	0x26	UDP or TCP port number
		LSB 12	0x16	
	Protocol	13	0x00	0 = UDP, 1= TCP - Protocol use for the transmitted data
	Transmit Options Bitfield	14	0x00	Bit field: BIT 1 = 1 - Terminate socket after tx complete 0 - Leave socket open (use TCP timeout). Ignore bit for UDP packets. All other bits are reserved and should be 0.
RF Data	15	0x48('H')	Up to 1400 bytes of data	
	16	0x65('e')		
	17	0x6C('l')		
	18	0x6C('l')		
	19	0x6F('o')		
Checksum	20	0xA6	0xFF minus the 8 bit sum of bytes from offset 3 to this byte.	

Rx (Receive) Packet: 64-bit

Frame Type: 0x80

This frame type is used by XBee when RF data is received using the XBee application service. It allows for software compatibility with other XBee modules such as 802.15.4. An example of this frame type is given below:

	Frame Fields		Offset	Example	Description	
API Packet	Start Delimiter		0	0x7E		
	Length		MSB 1	0x00	Number of bytes between the length and the checksum	
			LSB 2	0x10		
	API Frame Specific Data	API Frame Identifier		3	0x80	
		64-Bit Source Address		4	0x00	Align IP address to low 32-bits of the field. The other bytes set to 0. IP address is in hex. The example uses address 192.168.0.103
				5	0x00	
				6	0x00	
				7	0x00	
				8	0xC0	
				9	0xA8	
				10	0x00	
				11	0x67	
		RSSI		12	0x2E	Only tells RSSI at time of join (not updated with each reception).
		Options		13	0x00	None currently defined
	RF Data		14	0x48 'H'	Up to 1400 bytes of data	
		15	0x65 'e'			
		16	0x6C 'l'			
		17	0x6C 'l'			
		18	0x6F 'o'			
Checksum		19	0x8E	0xFF - the 8 bit sum of bytes from offset 3 to this byte.		

AT Command Response

Frame Type: 0x88

In response to an AT Command message, the module will send an AT Command Response message. Some commands will send back multiple frames (for example, the AS (Active Scan) command).

Example: Suppose the BD parameter is changed on the local device with a frame ID of 0x01. If successful (parameter was valid), the response below would be received.

	Frame Fields		Offset	Example	Description	
API Packet	Start Delimiter		0	0x7E		
	Length		MSB 1	0x00	Number of bytes between the length and the checksum	
			LSB 2	0x05		
	API Frame Specific Data	API Frame Identifier		3	0x88	
		Frame ID		4	0x01	
		AT Command		MSB 5	0x42 (B)	Command Name - Two ASCII characters that identify the AT command
				LSB 6	0x44 (D)	
		Status			0x00	0 = OK 1 = ERROR 2 = Invalid Command 3 = Invalid Parameter
Parameter Value		7		Register data in binary format. If the register was set, then this field is not returned, as in this example.		
Checksum		8	0xF0	0xFF minus the 8 bit sum of bytes from offset 3 to this byte.		

Modem Status

Frame Type: (0x8A)

RF module status messages are sent from the module in response to specific conditions.

Example: The following API frame is returned when a module is powered on in API mode.

	Frame Fields		Offset	Example	Description
API Packet	Start Delimiter		0	0x7E	
	Length		MSB 1	0x00	Number of bytes between the length and the checksum
			LSB 2	0x02	
	API Frame Specific Data	API Frame Identifier	3	0x8A	
		Status	4	0x00	0 = Hardware reset or power up 1 = Watchdog timer reset 2 = Joined 3 = No longer joined to access point 4 = IP configuration error Whenever the most significant bit of the Status byte is set, the WiFi transceiver is reporting a problem. For example: 0x8E = Failure to join access point
Checksum		5	0x75	0xFF minus the 8 bit sum of bytes from offset 3 to this byte.	

Note: New modem status codes may be added in future firmware releases.

Transmission Status

Frame Type: (0x89)

RF transmission status messages are sent from the module in response to transmission attempts.

Example: The following API frame is returned when a successful transmission occurs on an API transmission using frame ID 01.

	Frame Fields	Offset	Example	Description	
API Packet	Start Delimiter	0	0x7E		
	Length	MSB 1	0x00	Number of bytes between the length and the checksum	
		LSB 2	0x03		
	API Frame Specific Data	API Frame Identifier	3	0x89	
		Frame ID	4	0x01	Identifies the frame for which status is being reported. This number corresponds with the Frame ID provided in the transmission. If that frame ID was 0, then this frame will not be generated.
		Status	5	0x00	0x00 = Success 0x03 = Transmission was purged because it was attempted before stack was completely up. 0x04 = Physical error occurred on the interface with the WiFi transceiver. 0x21 = TX64 transmission timed out awaiting an acknowledgement from the remote device. 0x32 = Resource Error; Either buffers or sockets were depleted, preventing a transmission from occurring. 0x74 = Message not sent because it was too long 0x76 = Attempt to create a client socket failed
Checksum		6	0x75	0xFF minus the 8 bit sum of bytes from offset 3 to this byte.	

Note: New transmission status codes may be added in future firmware releases.

IO Data Sample RX Indicator

Frame Type: 0x8F

When the module receives an IO sample frame from a remote device, it sends the sample out the UART or SPI using this frame type. Only modules running API mode will be able to receive IO samples.

Example: The following is the IO sample response from a radio at IP address 192.168.0.103 reporting one active DIO (DIO8) and one active analog input (AN1).

	Frame Fields	Offset	Example	Description	
API Packet	Start Delimiter	0	0x7E		
	Length	MSB 1	0x00	Number of bytes between the length and the checksum	
		LSB 2	0x13		
	API Frame Specific Data	API Frame Identifier	3	0x8F	
		64-Bit Source Address	4	0x00	Align IP address to low 32-bits of the field. The other bytes set to 0. IP address is in hex. The example uses address 192.168.0.103
			5	0x00	
			6	0x00	
			7	0x00	
			8	0xC0	
			9	0xA8	
			10	0x00	
		11	0x67		
		RSSI at time of join	12	0x2E	
		Receive Options	13	0x00	None currently defined
		Number of samples	14	0x01	Number of sample sets included in the payload. (Always set to 1)
		Digital Channel Mask*	MSB 15	0x01	Bitmask field that indicates which digital IO lines on the remote have sampling enabled (if any). In this example DIO8 is active.
	LSB 16		0x00		
	Analog Channel Mask**	17	0x81	Bitmask field that indicates which analog IO lines on the remote have sampling enabled (if any). The most significant bit signals that the Vcc value is included in the frame. In this example Analog input 1 and Vcc are active.	
	Digital Samples (if included)	MSB 18	0x00	If the sample set includes any digital IO lines (Digital Channel Mask > 0), these two bytes contain samples for all enabled digital IO lines. DIO lines that do not have sampling enabled return 0. The bits in these 2 bytes map the same as they do in the Digital Channels Mask field. In this example, DIO8 has value 0.	
		LSB 19	0x00		
Analog Sample	MSB 20	0x03	If the sample set includes any analog input lines (Analog Channel Mask > 0), each enabled analog input returns a 2-byte value indicating the A/D measurement of that input. Analog samples are ordered sequentially from AD0/DIO0 to AD4/DIO4, to the supply voltage.		
	LSB 21	0xB5			
Checksum		22	0x38	0xFF - the 8 bit sum of bytes from offset 3 to this byte.	

*	N/A	N/A	N/A	CD/DIO 12	PWM/DI O11	RSSI/DI O10	N/A	N/A
	CTS/DI O7	RTS/DI O6	ASSOC DIO5	DIO4	AD3/DI O3	AD2/DI O2	AD1/DI O1	AD0/DI O0
**	Supply Voltage	N/A	N/A	N/A	AD3	AD2	AD1	AD0

Remote Command Response

Frame Type: 0x87

If a module receives a remote command response RF data frame in response to a Remote AT Command Request, the module will send a Remote AT Command Response message out the UART or SPI.

Example: If a remote command is sent to a remote device with an IP address of 192.168.0.103 to set the D1 parameter to 3 (digital input), the response is shown in the example API frame in the table below.

	Frame Fields	Offset	Example	Description		
API Packet	Start Delimiter	0	0x7E			
	Length	MSB 1	0x00	Number of bytes between the length and the checksum		
		LSB 2	0x0D			
	API Frame Specific Data	API Frame Identifier	3	0x87		
		Frame ID	4	0x01		
		64-Bit Responder Address		5	0x00	Align IP address to low 32-bits of the field. The other bytes set to 0. Value is in hex. In this example the IP address is 192.168.0.103
				6	0x00	
				7	0x00	
				8	0x00	
				9	0xC0	
				10	0xA8	
			11	0x00		
			12	0x67		
	AT Command	MSB 13	0x44 (D)	Command Name - Two ASCII characters that identify the AT command		
LSB 14		0x31 (1)				
Status	15	0x00	0 = OK 1 = ERROR 2 = Invalid Command 3 = Invalid Parameter 4 = Tx Failure			
Parameter Value		-	If present, indicates the requested parameter value to set the given register. If no characters present, register is queried.			
Checksum		16	0x33	0xFF minus the 8 bit sum of bytes from offset 3 to this byte.		

RX (Receive) Packet: IPv4

Frame Type: 0xB0

This frame is used by XBee when RF data is received using the Serial Data service on the port defined by the C0 command.

Example: When a module in API mode receives an IPv4 transmission, it will produce an RX notification (0xB0) and send it out the UART or SPI. This example is the response to a UDP transmission to IP address 192.168.0.103 with data 'Hello' from the source address 192.168.0.104.

Frame Fields		Offset	Example	Description
API Packet	Start Delimiter	0	0x7E	
	Length	MSB 1	0x00	Number of bytes between the length and the checksum
		LSB 2	0x10	
	API Frame Identifier	3	0xB0	
	IPv4 32 bit Source Address	MSB 4	0xC0	The address in the example is for a source address of 192.168.0.104
		5	0xA8	
		6	0x00	
		7	0x68	
	16 Bit Destination Port	MSB 8	0x26	Same value as the C0 command.
		LSB 9	0x16	
	16 bit Source Port	MSB 10	0x26	
		LSB 11	0x16	
	Protocol	MSB 12	0x00	0 = UDP, 1= TCP - Protocol use for the transmitted data
	Status	13	0x00	Reserved
	RF Data	14	0x48 'H'	Up to 1400 bytes of data
15		0x65 'e'		
16		0x6C 'l'		
17		0x6C 'l'		
18		0x6F 'o'		
Checksum	19	0x13	0xFF minus the 8 bit sum of bytes from offset 3 to this byte.	

8. XBee Command Reference Tables

Addressing

AT Command	Name and Description	Parameter Range	Default
DL	Destination Address Low. Set/Get the 32 bits of the IPv4 destination address. Using AT command mode this value is entered using dotted notation (example 192.168.0.100).	0.0.0.0 – 255.255.255.255	255.255.255.255
MY	IP Network Address. Read the 32-bit network address of the module when using DHCP. Set/Read values when using static IP address.	0.0.0.0 – 255.255.255.255	0.0.0.0
MK	IP Address Mask. This command is read only when DHCP is enabled.	0.0.0.0 – 255.255.255.255	0.0.0.0
GW	Gateway IP address. This command is read only when DHCP is enabled.	0.0.0.0 – 255.255.255.255	0.0.0.0
SH	Serial Number High. Read the high 16 bits of the module's unique 48-bit address.	0 - 0xFFFFFFFF [read-only]	factory-set
SL	Serial Number Low. Read the low 32 bits of the module's unique 48-bit address.	0 - 0xFFFFFFFF [read-only]	factory-set
NI	Node Identifier. Stores a string identifier. The register only accepts printable ASCII data. In AT Command Mode, a string cannot start with a space. A carriage return ends the command. Command will automatically end when maximum bytes for the string have been entered.	20-Byte printable ASCII string	ASCII space character (0x20)
DE	Destination Port. Set/Get destination UDP/TCP port value.	0 - 0xFFFF	0x2616
CO	Serial Communication Service Port. Set/Get port number used to provide the serial communication service. Data sent to this port will come out of the serial port of the module. The protocol used is set by the IP command when UART is in transparent mode.	0 – 0xFFFF	0x2616
DD	Device Type Identifier. Stores a device type value. This value can be used to differentiate different XBee-based devices. Digi reserves the range 0 - 0xFFFFF.	0-0xFFFFFFFF	0x50000
NP	Maximum RF Payload Bytes. This value returns the maximum number of RF payload bytes that can be sent in a transmission Note: NP returns a hexadecimal value. (e.g. if NP returns 0x54, this is equivalent to 84 bytes)	0 - 0xFFFF	[read-only]

Networking Commands

AT Command	Name and Description	Parameter Range	Default
ID	SSID. Set/read the SSID of the access point, which may be up to 31 ASCII characters	Up to 31 bytes of printable ASCII	NULL
AH	Network Type. Set/read network type. Network types supported are Infrastructure (using an access point) and Adhoc (IBSS).	0-IBSS Joiner 1-IBSS Creator 2 - Infrastructure	2
IP	IP Protocol. Set/Read the protocol used for the serial communication service. This is the port used by the CO command.	0 – UDP 1 - TCP	0
MA	IP Addressing Mode. Set / read the IP addressing mode.	0 – DHCP 1 – Static	0
TM	TCP timeout. Set/Read the timeout for connection on TCP socket. If 0, socket closes immediately after data sent.	0-0xFF [x 100 msec]	0x0A

Security Commands

AT Command	Name and Description	Parameter Range	Default
EE	Encryption Enable. Set/Read the encryption enable setting.	0 – No security 1 – WPA 2 – WPA2	0
PK	Security Key. Set the security key used for WPA and WPA2 security. This command is write only; PK cannot be read.	0-31-ASCII characters	

RF Interfacing Commands

AT Command	Name and Description	Parameter Range	Default
PL	Power Level. Select/Read the power level at which the RF module transmits conducted power.	0– 7 dBm 1-7 dBm 2- 7 dBm 3- 10 dBm 4- 15 dBm	4
CH	Channel. Read the channel number of the access point or 0xFF if not associated. Channel can be set when AH is configured for Adhoc creator mode. Note when using Adhoc mode, not all channels are available in all countries. It is the responsibility of the installer to use the appropriate channels.	1-0xE	[read only]
BR	Bit Rate of IBSS Creator. Data rates MCS0-7 are 802.11n data rates from 6.5 Mbps to 65Mbps. If not IBSS creator, 0 (auto-rate) is the only valid rate.	0- Auto-rate 1- 1 Mbps 2 – 2 Mbps 3 – 5.5 Mbps 4 – 11 Mbps 5 – 6 Mbps 6 – 9 Mbps 7 – 12 Mbps 8 – 18 Mbps 9 – 24 Mbps 0x0A – 36 Mbps 0x0B – 48 Mbps 0x0C – 54 Mbps 0x0D – MCS0 0x0E – MCS1 0x0F – MCS2 0x10 – MCS3 0x11 – MCS4 0x12 – MCS5 0x13 – MCS6 0x14 – MCS7	0

Serial Interfacing

AT Command	Name and Description	Parameter Range	Default
AP	API Enable. Enable API Mode.	0 = Transparent mode 1 = API-enabled 2 = API-enabled (w/escaped control characters)	1
BD	Interface Data Rate. Set/Read the serial interface data rate for communication between the module serial port and host. Any value above 0x08 will be interpreted as an actual baud rate. When a value above 0x08 is sent, the closest interface data rate represented by the number is stored in the BD register.	0 - 7 (standard baud rates) 0 = 1200 bps 1 = 2400 2 = 4800 3 = 9600 4 = 19200 5 = 38400 6 = 57600 7 = 115200 8 = 230400 0x100 - 0xE1000 (non-standard rates up to 921kbps)	3
NB	Serial Parity. Set/Read the serial parity setting on the module.	0 = No parity 1 = Even parity 2 = Odd parity	0
SB	Stop Bits. Set/read the number of stop bits for the UART. (Two stop bits are not supported if mark parity is enabled.)	0 = 1 stop bit 1 = 2 stop bits	0
RO	Packetization Timeout. Set/Read number of character times of inter-character silence required before packetization. Set (RO=0) to transmit characters as they arrive instead of buffering them into one RF packet. Regardless of how small RO is, the inter-character silence required to trigger a transmission of the data is 100 usec.	0 - 0xFF [x character times]	3
FT	Flow Control Threshold. De-assert CTS when FT bytes are in the UART receive buffer	0x11 – 0x823	0x7F3
D7	DIO7 Configuration. Select/Read options for the DIO7 line of the RF module.	0 = Disabled 1 = CTS Flow Control 3 = Digital input 4 = Digital output, low 5 = Digital output, high 6 = RS-485 transmit enable (low enable) 7 = RS-485 transmit enable (high enable)	1
D6	DIO6 Configuration. Configure options for the DIO6 line of the RF module.	0 = Disabled 1 = RTS flow control 3 = Digital input 4 = Digital output, low 5 = Digital output, high	0

I/O Settings

AT Command	Name and Description	Parameter Range	Default
IR	IO Sample Rate. Set/Read the IO sample rate to enable periodic sampling. For periodic sampling to be enabled, IR must be set to a non-zero value, and at least one module pin must have analog or digital IO functionality enabled (see D0-D8, P0-P2 commands). The sample rate is measured in milliseconds.	0-0xFFFF (x 1 ms)	0 – no sampling
IC	IO Digital Change Detection. Set/Read the digital IO pins to monitor for changes in the IO state. IC works with the individual pin configuration commands (D0-D9, P0-P2). If a pin is enabled as a digital input/output, the IC command can be used to force an immediate IO sample transmission when the DIO state changes. IC is a bitmask that can be used to enable or disable edge detection on individual channels. Unused bits should be set to 0.	0 - 0xFFFF	0
IF	Sample from Sleep Rate. The number of sleep cycles that must elapse between periodic I/O samples. This allows I/O samples to be taken only during some wake cycles. During those cycles I/O samples are taken at the rate specified by IR. IR can be 0 which will cause only one sample to be taken.	1-0xFF (1 gives you a sample every sleep cycle)	1
P0	DIO10 Configuration. Select/Read function for the DIO10 line of the RF module.	0 = Disabled, 2 = PWM0 Output 3 = Digital input, monitored 4 = Digital output, default low 5 = Digital output, default high	0
P1	DIO11 Configuration. Select/Read function for the DIO11 line of the RF module.	0 = Disabled 2 = PWM1 Output 3 = Digital input, monitored 4 = Digital output, default low 5 = Digital output, default high	0
P2	DIO12 Configuration. Select/Read function for the DIO12 line of the RF module.	0 = Disabled 1 = SPI_MISO 3 = Digital input, monitored 4 = Digital output, default low 5 = Digital output, default high	0
P3	DOUT. Enables or disables output on UART port	0 = Disabled 1 = Enabled	1
P4	DIN. Enables or disables input on UART port	0 = Disabled 1 = Enabled	1

AT Command	Name and Description	Parameter Range	Default
D0	AD0/DIO0 Configuration. Select/Read function for AD0/DIO0.	0 = Disabled 2 = Analog input 3 = Digital input, monitored 4 = Digital output, default low 5 = Digital output, default high	0
D1	AD1/DIO1 Configuration. Select/Read function for AD1/DIO1	0 - Disabled 1 = SPI Attention 2 = Analog input 3 = Digital input, monitored 4 = Digital output, default low 5 = Digital output, default high	0
D2	AD2/DIO2 Configuration. Select/Read function for AD2/DIO2	0 = Disabled 1 = SPI Clock 2 = Analog input 3 = Digital input, monitored 4 = Digital output, default low 5 = Digital output, default high	0
D3	AD3/DIO3 Configuration. Select/Read function for AD3/DIO3.	0 = Disabled 1 = SPI Slave Select 2 = Analog input 3 = Digital input, monitored 4 = Digital output, default low 5 = Digital output, default high	0
D4	DIO4 Configuration. Select/Read function for DIO4.	0 = Disabled 1 = SPI_MOSI 2 = Analog input 3 = Digital input, monitored 4 = Digital output, default low 5 = Digital output, default high	0
D5	DIO5 Configuration. Select/Read function for DIO5.	0 = Disabled 1 = Associated LED 3 = Digital input 4 = Digital output, default low 5 = Digital output, default high	1

AT Command	Name and Description	Parameter Range	Default
D8	DIO8 Configuration. Select/Read function for DIO8.	0 = Disabled 1 = SleepRq 3 = Digital input, monitored 4 = Digital output, default low 5 = Digital output, default high	1
D9	DIO9 Configuration. Select/Read function for DIO9	0 = Disabled 1 = On/Sleep indicator 3 = Digital input, monitored 4 = Digital output, default low 5 = Digital output, default high	1
LT	Assoc LED Blink Time. Set/Read the Associate LED blink time. If the Associate LED functionality is enabled (D5 command), this value determines the on and off blink times for the LED when the module has joined a network. If LT=0, the default blink rate of 250ms will be used. For all other LT values, LT is measured in 10ms.	0, 0x14 - 0xFF (200 - 2550 ms)	0
PR	Pull-up Resistor. Set/read the bit field that configures the internal resistor status for the I/O lines. "1" specifies the resistor is enabled. "0" specifies no resistor. The PD command specifies whether the resistor is pull-up or pull-down. Bits: 0 - DIO4 (Pin 11) 1 - AD3 / DIO3 (Pin 17) 2 - AD2 / DIO2 (Pin 18) 3 - AD1 / DIO1 (Pin 19) 4 - AD0 / DIO0 (Pin 20) 5 - RTS / DIO6 (Pin 16) 6 - DTR / Sleep Request / DIO8 (Pin 9) 7 - DIN / Config (Pin 3) 8 - Associate / DIO5 (Pin 15) 9 - On/Sleep / DIO9 (Pin 13) 10 - DIO12 (Pin 4) 11 - DIO10 / PWM0 (Pin 6) 12 - DIO11/PWM1 (Pin 7) 13 - CTS / DIO7 (Pin 12)	0 - 0x7FFF	0x7FFF
PD	Pull Direction. Set/Read resistor direction for the corresponding bits set in PR. If the bit is not set in PR, then PD is unused.	0 - 0x7FFF	0x7FFF
AV	Analog Voltage Reference. Set/Read the analog voltage reference. This specifies the volts for an analog reading of 0x03ff, where a reading of 0x200 indicates a voltage input that is half of VREF. VREF may be one of these two values: 0 - 1.25Volts 1 - 2.5 Volts	0-1	1
M0	PWM0 Duty cycle. Sets the duty cycle of PWM0 for P0=2, where a value of 0x200 is a 50% duty cycle.	0 - 0x03FF	0
M1	PWM1 Duty cycle. Sets the duty cycle of PWM1 for P1=2, where a value of 0x200 is a 50% duty cycle.	0 - 0x03FF	0

Diagnostics Interfacing

AT Command	Name and Description	Parameter Range	Default
VR	Firmware Version. Read firmware version of the module. The firmware version returns 4 hexadecimal values (2 bytes) "ABCD". Digits ABC are the main release number and D is the revision number from the main release. "B" is a variant designator where 0 means standard release.	0 - 0xFFFF [read-only]	Factory-set
HV	Hardware Version. Read the hardware version of the module. This command can be used to distinguish among different hardware platforms. The upper byte returns a value that is unique to each module type. The lower byte indicates the hardware revision. XBee WiFi modules return 0x1Fxx for the HV command.	0 - 0xFFFF [read-only]	Factory-set
AI	Association Indication. Read information regarding last node join request: 0x00 - Successfully joined an access point, established IP addresses and IP listening sockets. 0x01 – WiFi initialization in progress. This status should only be seen for a few milliseconds. 0x22 – Selected SSID not found 0x23 – SSID not configured. (An active scan can occur in this state. 0x27 – SSID was found, but join failed 0xff – Module is currently scanning for the configured SSID 0x41 – Module joined a network and is waiting for IP configuration to complete, which usually means it is waiting for a DHCP provided address 0x42 – Module is joined, IP is configured, and listening sockets are being set up Note: New non-zero AI values may be added in later firmware versions. Applications should read AI until it returns 0x00, indicating a successful startup (coordinator) or join (routers and end devices)	0 - 0xFFFF [read-only]	-
AS	Active Scan. Scan for access points in the vicinity. This command can only be issued when SSID is NULL, which can be forced by first issuing the NR command. If SSID is not NULL, then the active scan command returns an error. This command may be issued in command mode or in API mode. In either case, the following information is returned for each access point found: 01 – Indicates scan type of 802.11 FF – Place holder for future use ST – Security type where: 00=open, 01=WPA, 02=WPA2, and 03=WPA RS – RSSI of access point (negated hex value ID = SSID of access point found. When this command is issued in command mode, the above record is displayed, one per line for each access point found. Readable ASCII characters are output with commas between fields and carriage returns between records. When it is issued in API mode, each record (i.e. each access point) outputs a separate AT command response of type 0x88 with the above fields in binary format. Note that this command is not available as a remote command.	-	-
TP	Temperature. Read temperature of module in degrees Celsius.	-40 to 85C	-
CK	Configuration Code. Read the configuration code associated with the current AT command configuration	2 bytes	-
%V	Supply Voltage. Read supply voltage in millivolt units.	3.1 to 3.6V	-
DB	RSSI. Reads the value of the RSSI of the access point when it was last joined (or 0xff if is not joined to an access point.) RSSI is measured in negative dBm units. Therefore, the larger the number, the weaker the signal.	0 – 0xff	

AT Command Options

AT Command	Name and Description	Parameter Range	Default
CT	Command Mode Timeout. Set/Read the period of inactivity (no valid commands received) after which the RF module automatically exits AT Command Mode and returns to Idle Mode. This time can be up to ten minutes.	2 - 0x1770 [x 100 ms]	0x64 (100d)
CN	Exit Command Mode. Explicitly exit the module from AT Command Mode. (Whether command mode is left by the CN command or by CT timing out, changes will be applied upon exit.	-	-
GT	Guard Times. Set required period of silence before and after the Command Sequence Characters of the AT Command Mode Sequence (GT + CC + GT). The period of silence is used to prevent inadvertent entrance into AT Command Mode.	2 - 0x0CE4 [x 1 ms] ² (max of 3.3 decimal sec)	0x3E8 (1000d)
CC	Command Mode Character Set/read the command mode character used between guard times of the AT Command Mode Sequence (GT + CC + CC + CC + GT). This sequence allows the module to enter into AT Command Mode.	0 - 0xFF	0x2B (‘+’ ASCII)

Sleep Commands

AT Command	Name and Description	Parameter Range	Default
SM	Sleep Mode Sets the sleep mode on the RF module. Sleep mode is also affected by the SO command, option bit 6. See the “Sleep” chapter for a full explanation of the various sleep modes.	0 = No sleep 1 = Pin sleep 4 = Cyclic sleep 5 = Cyclic sleep, pin wake	0
SP	Sleep Period. This value determines how long the device will sleep at a time, up to 24 hours or 86,400 seconds. This corresponds to 0x83d600 in 10ms units.	1 - 0x83D600 x 10ms	0xC8 (2 seconds)
SO Command	Sleep Options. Configure options for sleep. Unused option bits should be set to 0. Sleep options include: 0x40 – Stay associated with AP during sleep. Draw more current during sleep with this option enabled, but also awake from sleep more rapidly. 0x100 – For cyclic sleep, ST specifies the time before returning to sleep. With this bit set, new receptions from either the serial or the RF port will NOT restart the ST timer. Current implementation does not support this bit being turned off.	0 - 0x01FF	0x100
WH	Wake Host. Set/Read the wake host timer value. If the wake host timer is set to a non-zero value, this timer specifies a time (in millisecond units) that the device should allow after waking from sleep before sending data out the UART or transmitting an IO sample. If serial characters are received, the WH timer is stopped immediately.	0 - 0xFFFF (x 1ms)	0
ST	Wake Time. Wake time for cyclic modes. New data will not refresh the timer. However, if there is data to transmit or receive after ST expires, those actions will occur before the module goes to sleep. Max wake time is 3600 seconds.	0x1 – 0x36EE80 (x 1 ms)	0x7D0

Execution Commands

Where most AT commands set or query register values, execution commands cause an action to be executed on the module. Execution commands are executed immediately and do not require changes to be applied.

AT Command	Name and Description	Parameter Range	Default
AC	Apply Changes. Applies changes to all command registers causing queued command register values to be applied. For example, changing the serial interface rate with the BD command will not change the UART interface rate until changes are applied with the AC command. The CN command and 0x08 API command frame also apply changes.	-	-
WR	Write. Write parameter values to non-volatile memory so that parameter modifications persist through subsequent resets. Note: Once WR is issued, no additional characters should be sent to the module until after the "OK\r" response is received. The WR command should be used sparingly to preserve flash.	-	-
RE	Restore Defaults. Restore module parameters to factory defaults.	-	-
FR	Software Reset. Reset module. Responds immediately with an OK status, and then performs a software reset about 2 seconds later.	-	-
NR	Network Reset. Reset network layer. For WiFi, this means to disassociate from the access point and set SSID to NULL, thereby preventing the node from immediately establishing the same connection with the same access point. This also allows the active scan command to be executed so that access point candidates can be selected from the resultant list. Note that NR and NRO both do the same thing and may be used interchangeably.	0	-
IS	Force Sample Forces a read of all enabled digital and analog input lines.	-	-

9. Module Support

This chapter provides customization information for the XBee Wi-Fi module. In addition to providing an extremely flexible and powerful API, the XBee module is a robust development platform that has passed FCC and ETSI testing.

X-CTU Configuration Tool

Digi provides a Windows X-CTU configuration tool for configuring module parameters and updating firmware. The XCTU has the capability to do the following:

- Update firmware on a local module (requires USB or serial connection)
- Read or write module configuration parameters on a local
- Save and load configuration profiles containing customized settings.

Contact Digi support for more information about the X-CTU.

Serial Firmware Updates

Serial firmware updates make use of the XBee bootloader which ships in all modules. This bootloader allows firmware to be updated. Normally, the running application can be told to invoke the bootloader through a command from X-CTU. If that command is not available in the currently loaded firmware, the bootloader includes a modified entry mechanism using pins 3, 9, and 16 (DIN, DTR, and RTS, respectively). By driving pin 3 low, pin 9 low, and pin 16 high at the time the module is reset, the XBee bootloader is forced to run, allowing a new version of firmware to load. This method works even when the current firmware version does not support the firmware upgrade feature.

The X-CTU program can update firmware on the XBee module over the UART port, but not currently over the SPI port. Contact Digi support for details.

Regulatory Compliance

XBee modules are certified for FCC and IC operation on all 11 channels (1-11) allowable, and ETSI certified for all 13 channels (1-13) allowable.

10. Agency Certifications

United States FCC

This device complies with Part 15 of the FCC Rules. Operation is subject to the following two conditions: (1) this device may not cause harmful interference and (2) this device must accept any interference received, including interference that may cause undesired operation.

The XBee RF Module complies with Part 15 of the FCC rules and regulations. Compliance with the labeling requirements, FCC notices and antenna usage guidelines is required.

To fulfill FCC Certification, the OEM must comply with the following regulations:

1. The system integrator must ensure that the text on back side of the module is placed on the outside of the final product.
2. XBee RF Module may only be used with antennas that have been tested and approved for use with this module [refer to the antenna tables in this section].

OEM Labeling Requirements



WARNING: The Original Equipment Manufacturer (OEM) must ensure that FCC labeling requirements are met. This includes a clearly visible label on the outside of the final product enclosure.

Required FCC Label for OEM products containing the XBee S6 RF Module
Contains FCC ID: MCQ-XBS6

The integrator is responsible for its product to comply with FCC Part 15, Sub. B - Unintentional Radiators.

FCC Notices

IMPORTANT: The XBee Module have been certified by the FCC for use with other products without any further certification (as per FCC section 2.1091). Modifications not expressly approved by Digi could void the user's authority to operate the equipment.

IMPORTANT: OEMs must test final product to comply with unintentional radiators (FCC section 15.107 & 15.109) before declaring compliance of their final product to Part 15 of the FCC Rules.

IMPORTANT: The RF module has been certified for remote and base radio applications. If the module will be used for portable applications, the device must undergo SAR testing.

This equipment has been tested and found to comply with the limits for a Class B digital device, pursuant to Part 15 of the FCC Rules. These limits are designed to provide reasonable protection against harmful interference in a residential installation. This equipment generates, uses and can radiate radio frequency energy, and if not installed and used in accordance with the instructions, may cause harmful interference to radio communications. However, there is no guarantee that interference will not occur in a particular installation.

If this equipment does cause harmful interference to radio or television reception, which can be determined by turning the equipment off and on, the user is encouraged

to try to correct the interference by one or more of the following measures: Re-orient or relocate the receiving antenna, Increase the separation between the equipment and receiver, Connect equipment and receiver to outlets on different circuits, or Consult the dealer or an experienced radio/TV technician for help.

FCC-Approved Antennas (2.4 GHz)

The XBee Wi-Fi Module can be installed utilizing antennas and cables constructed with non-standard connectors (RPSMA, RPTNC, etc.).

The modules are FCC approved for fixed base station and mobile applications for the channels indicated in the tables below. If the antenna is mounted at least 20cm (8 in.) from nearby persons, the application is considered a mobile application. Antennas not listed in the table must be tested to comply with FCC Section 15.203 (Unique Antenna Connectors) and Section 15.247 (Emissions).

XBee Wi-Fi Module: XBee RF Modules have been tested and approved for use with all the antennas listed in the tables below. (Cable-loss is required when using gain antennas as shown below.)

The antennas in the tables below have been approved for use with this module. Digi does not carry all of these antenna variants. Contact Digi Sales for available antennas.

Antennas approved for use with the XBee Wi-Fi Module

Integrated Antennas							
Part Number	Type (Description)	Gain	Application	Min Separation	Minimum Cable Loss/Power Reduction/Attenuation Required		
					b mode	g mode	n mode
	Integrated PCB antenna	0 dBi	Fixed/Mobile	20 cm	N/A	N/A	N/A
29000294	Integral PCB antenna	-0.5 dBi	Fixed/Mobile	20 cm	N/A	N/A	N/A
A24-QI	Monopole (Integrated Whip)	1.5 dBi	Fixed/Mobile	20 cm	N/A	N/A	N/A

Dipole Antennas							
Part Number	Type (Description)	Gain	Application	Min Separation	Minimum Cable Loss/Power Reduction/Attenuation Required		
					b mode	g mode	n mode
A24-HASM-450	Dipole (Half-wave articulated RPSMA-4.5")	2.1 dBi	Fixed/Mobile	20 cm	N/A	N/A	N/A
A24-HABSM	Dipole (Articulated RPSMA)	2.1 dBi	Fixed	20 cm	N/A	N/A	N/A
A24-HABUF-P5I	Dipole (Half-wave bulkhead mount U.F.L s/ 5" pigtail)	2.1 dBi	Fixed	20 cm	N/A	N/A	N/A
A24-HASM-525	Dipole (Half-wave articulated RPSMA-5.25")	2.1 dBi	Fixed/Mobile	20 cm	N/A	N/A	N/A

Omi-Directional Antennas							
Part Number	Type (Description)	Gain	Application	Min Separation	Minimum Cable Loss/Power Reduction/Attenuation Required		
					b mode	g mode	n mode
A24-F2NF	Omin-Directional (Fiberglass base station)	2.1 dBi	Fixed/Mobile	20 cm	N/A	N/A	N/A
A24-F3NF	Omin-Directional (Fiberglass base station)	3.0 dBi	Fixed/Mobile	20 cm	N/A	N/A	N/A
A24-F5NF	Omin-Directional (Fiberglass base station)	5.0 dBi	Fixed	20 cm	N/A	N/A	0.12dB
A24-F8NF	Omin-Directional (Fiberglass base station)	8.0 dBi	Fixed	2 m	N/A	N/A	3.12dB
A24-F9NF	Omin-Directional (Fiberglass base station)	9.5 dBi	Fixed	2 m	N/A	1.0dB	4.62dB
A24-F10NF	Omin-Directional (Fiberglass base station)	10 dBi	Fixed	2 m	N/A	1.5dB	5.12dB
A24-F12NF	Omin-Directional (Fiberglass base station)	12 dBi	Fixed	2 m	N/A	3.5dB	7.12dB
A24-F15NF	Omin-Directional (Fiberglass base station)	15 dBi	Fixed	2 m	0.56dB	6.5dB	10.12dB
A24-W7NF	Omin-Directional (base station)	7.2 dBi	Fixed	2 m	N/A	N/A	2.32dB
A24-M7NF	Omin-directional (Mag-mount base station)	7.2 dBi	Fixed	2 m	N/A	N/A	2.32dB

PANEL CLASS ANTENNAS							
Part Number	Type (Description)	Gain	Application	Min Separation	Minimum Cable Loss/Power Reduction/Attenuation Required		
					b mode	g mode	n mode
A24-P8SF	Flat Panel	8.5 dBi	Fixed	2 m	N/A	5.96dB	10.04dB
A24-P8NF	Flat Panel	8.5 dBi	Fixed	3 m	N/A	5.96dB	10.04dB
A24-P13NF	Flat Panel	13 dBi	Fixed	4 m	N/A	10.46dB	14.54dB
A24-P14NF	Flat Panel	14 dBi	Fixed	5 m	N/A	11.46dB	15.54dB
A24-P15NF	Flat Panel	15.0 dBi	Fixed	2 m	0.12dB	12.46dB	16.54dB
A24-P16NF	Flat Panel	16.0 dBi	Fixed	2 m	1.12dB	13.46dB	17.54dB
A24-19NF	Flat Panel	19.0 dBi	Fixed	2 m	4.12dB	16.46dB	20.54dB

YAGI CLASS ANTENNAS for Channel 11-25							
Part Number	Type (Description)	Gain	Application	Min Separation	Minimum Cable Loss/Power Reduction/Attenuation Required		
					b mode	g mode	n mode
A24-Y6NF	Yagi (6 element)	8.8dBi	Fixed	2 m	N/A	5.58dB	7.52dB
A24-Y7NF	Yagi (7 element)	9.0 dBi	Fixed	2 m	N/A	5.78dB	7.72dB
A24-Y9NF	Yagi (9 element)	10.0 dBi	Fixed	2 m	N/A	6.78dB	8.72dB
A24-Y10NF	Yagi (10 element)	11.0 dBi	Fixed	2 m	N/A	7.78dB	9.72dB
A24-Y12NF	Yagi (12element)	12.0 dBi	Fixed	2 m	N/A	8.78dB	10.72dB
A24-Y13NF	Yagi (13 element)	12.0 dBi	Fixed	2 m	N/A	8.78dB	10.72dB
A24-Y15NF	Yagi (15 element)	12.5 dBi	Fixed	2 m	N/A	9.28dB	11.22dB
A24-Y16NF	Yagi (16 element)	13.5 dBi	Fixed	2 m	N/A	10.28dB	12.22dB
A24-Y16RM	Yagi (16 element, RPSMA connector)	13.5 dBi	Fixed	2 m	N/A	10.28dB	12.22dB
A24-Y18NF	Yagi (18 element)	15.0 dBi	Fixed	2 m	0.56dB	11.78dB	13.72dB

*** If using the RF module in a portable application** (for example - if the module is used in a handheld device and the antenna is less than 20cm from the human body when the device is in operation): The integrator is responsible for passing additional SAR (Specific Absorption Rate) testing based on FCC rules 2.1091 and FCC Guidelines for Human Exposure to Radio Frequency Electromagnetic Fields, OET Bulletin and Supplement C. The testing results will be submitted to the FCC for approval prior to selling the integrated unit. The required SAR testing measures emissions from the module and how they affect the person.

RF Exposure



WARNING: To satisfy FCC RF exposure requirements for mobile transmitting devices, a separation distance of 20 cm or more should be maintained between the antenna of this device and persons during device operation. To ensure compliance, operations at closer than this distance are not recommended. The antenna used for this transmitter must not be co-located in conjunction with any other antenna or transmitter.

The preceding statement must be included as a CAUTION statement in OEM product manuals in order to alert users of FCC RF Exposure compliance.

Europe (ETSI)

The XBee RF Module has been certified for use in several European countries. For a complete list, refer to www.digi.com

If the XBee RF Modules are incorporated into a product, the manufacturer must ensure compliance of the final product to the European harmonized EMC and low-voltage/safety standards. A Declaration of Conformity must be issued for each of these standards and kept on file as described in Annex II of the R&TTE Directive.

Furthermore, the manufacturer must maintain a copy of the XBee user manual documentation and ensure the final product does not exceed the specified power ratings (For Channel 13 at temperatures below -20C PL3 is the highest certified power.), antenna specifications, and/or installation requirements as specified in the user manual. If any of these specifications are exceeded in the final product, a submission must be made to a notified body for compliance testing to all required standards.

OEM Labeling Requirements

The 'CE' marking must be affixed to a visible location on the OEM product.

CE Labeling Requirements

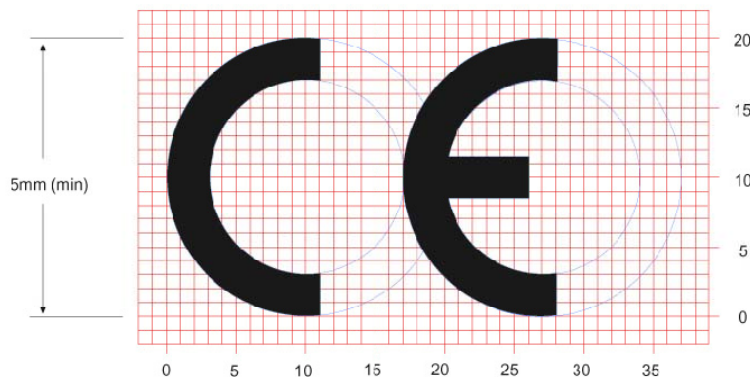

The CE mark shall consist of the initials "CE" taking the following form:

- If the CE marking is reduced or enlarged, the proportions given in the above graduated drawing must be respected.
- The CE marking must have a height of at least 5mm except where this is not possible on account of the nature of the apparatus.
- The CE marking must be affixed visibly, legibly, and indelibly.

Restrictions

Declarations of Conformity

Digi has issued Declarations of Conformity for the XBee RF Modules concerning emissions, EMC and safety. Files can be obtained by contacting Digi Support.

Important Note:

Digi does not list the entire set of standards that must be met for each country. Digi customers assume full responsibility for learning and meeting the required guidelines for each country in their distribution market. For more information relating to European compliance of an OEM product incorporating the XBee RF Module, contact Digi, or refer to the following web sites:

CEPT ERC 70-03E - Technical Requirements, European restrictions and general requirements: Available at www.ero.dk/.

R&TTE Directive - Equipment requirements, placement on market: Available at www.ero.dk/.

Approved Antennas

When integrating high-gain antennas, European regulations stipulate EIRP power maximums. Use the following guidelines to determine which antennas to design into an application.

XBee Wi-Fi RF Module

The following antennas types have been tested and approved for use with the XBee Module: *XBee® Wi-Fi RF Modules © 2010 Digi International, Inc. 151*

Antenna Type: Yagi

RF module was tested and approved with 15 dBi antenna gain with 1 dB cable-loss (EIRP Maximum of 14 dBm). Any Yagi type antenna with 14 dBi gain or less can be used with no cable-loss.

Antenna Type: Omni-Directional

RF module was tested and approved with 15 dBi antenna gain with 1 dB cable-loss (EIRP Maximum of 14 dBm). Any Omni-Directional type antenna with 14 dBi gain or less can be used with no cable-loss.

Antenna Type: Flat Panel

RF module was tested and approved with 19 dBi antenna gain with 4.8 dB cable-loss (EIRP Maximum of 14.2 dBm). Any Flat Panel type antenna with 14.2 dBi gain or less can be used with no cable-loss.

XBee RF Module

The following antennas have been tested and approved for use with the embedded XBee RF Module:

- Dipole (2.1 dBi, Omni-directional, Articulated RPSMA, Digi part number A24-HABSM)
- PCB Antenna (0 dBi)
- Wire Whip Antenna (1.5 dBi)

Canada (IC)

This device complies with Industry Canada licence-exempt RSS standard(s). Operation is subject to the following two conditions: (1) this device may not cause interference, and (2) this device must accept any interference, including interference that may cause undesired operation of the device.

Le présent appareil est conforme aux CNR d'Industrie Canada applicables aux appareils radio exempts de licence. L'exploitation est autorisée aux deux conditions suivantes : (1) l'appareil ne doit pas produire de brouillage, et (2) l'utilisateur de l'appareil doit accepter tout brouillage radioélectrique subi, même si le brouillage est susceptible d'en compromettre le fonctionnement

Labeling Requirements

Labeling requirements for Industry Canada are similar to those of the FCC. A clearly visible label on the outside of the final product enclosure must display the following text:

Contains IC: 1846A-XBS6

The integrator is responsible for its product to comply with IC ICES-003 & FCC Part 15, Sub. B - Unintentional Radiators. ICES-003 is the same as FCC Part 15 Sub. B and Industry Canada accepts FCC test report or CISPR 22 test report for compliance with ICES-003.

Transmitters with Detachable Antennas

This radio transmitter (IC: 1846A-XBS6) has been approved by Industry Canada to operate with the antenna types listed in the table above with the maximum permissible gain and required antenna impedance for each antenna type indicated. Antenna types not included in this list, having a gain greater than the maximum gain indicated for that type, are strictly prohibited for use with this device.

Le présent émetteur radio (IC: 1846A-XBS6) a été approuvé par Industrie Canada pour fonctionner avec les types d'antenne énumérés ci-dessous et ayant un gain admissible maximal et l'impédance requise pour chaque type d'antenne. Les types d'antenne non inclus dans cette liste, ou dont le gain est supérieur au gain maximal indiqué, sont strictement interdits pour l'exploitation de l'émetteur.

Detachable Antenna

Under Industry Canada regulations, this radio transmitter may only operate using an antenna of a type and maximum (or lesser) gain approved for the transmitter by Industry Canada. To reduce potential radio interference to other users, the antenna type and its gain should be so chosen that the equivalent isotropically radiated power (e.i.r.p.) is not more than that necessary for successful communication.

Conformément à la réglementation d'Industrie Canada, le présent émetteur radio peut fonctionner avec une antenne d'un type et d'un gain maximal (ou inférieur) approuvé

pour l'émetteur par Industrie Canada. Dans le but de réduire les risques de brouillage radioélectrique à l'intention des autres utilisateurs, il faut choisir le type d'antenne et son gain de sorte que la puissance isotrope rayonnée équivalente (p.i.r.e.) ne dépasse pas l'intensité nécessaire à l'établissement d'une communication satisfaisante.

Australia (C-Tick)

These modules comply with requirements to be used in end products in Australia. All products with EMC and radio communications must have a registered C-Tick mark. Registration to use the compliance mark will only be accepted from Australian manufacturers or importers, or their agent, in Australia. In order to have a C-Tick mark on an end product, a company must comply with a or b below.

- a. have a company presence in Australia.
- b. have a company/distributor/agent in Australia that will sponsor the importing of the end product.

Contact Digi for questions related to locating a contact in Australia.

Japan (TELEC)

These modules comply with requirements to be used in end products in Japan.

Approved Antennas Table

Antenna	Type	Antenna Gain (dBi)	Max Power (dBm/MHz)	EIRP (dBm/MHz)	½ Angle	Half Power Beamwidth Limit	Antenna Valid
Integral PCB	Omni	-0.5	7.37	6.87	--	--	yes
Dipole bec AN2400-37A19BX	Omni	2.76	7.37	10.13	--	--	yes
Dipole bec R-AN2400-5701RS-Z	Omni	3.45	7.37	10.82	--	--	yes
¼ Wave Monopole Maxstream	Omni	1.8	7.37	9.17	--	--	yes
½ Wave Dipole Nearson S131AH-2450S	Omni	2	7.37	9.37	--	--	yes
Dipole Pulse W1030	Omni	2	7.37	9.37	--	--	yes
Dipole Pulse W1049B050	Omni	2	7.37	9.37	--	--	yes
Buffalo WLE-HG-DA	Dir 70°	9	7.37	16.37	35°	135.9°	yes

11. Warranty Information

1-Year Warranty

XBee RF Modules from Digi International, Inc. (the "Product") are warranted against defects in materials and workmanship under normal use, for a period of 1-year from the date of purchase. In the event of a product failure due to materials or workmanship, Digi will repair or replace the defective product. For warranty service, return the defective product to Digi International, shipping prepaid, for prompt repair or replacement.

The foregoing sets forth the full extent of Digi International's warranties regarding the Product. Repair or replacement at Digi International's option is the exclusive remedy. THIS WARRANTY IS GIVEN IN LIEU OF ALL OTHER WARRANTIES, EXPRESS OR IMPLIED, AND DIGI SPECIFICALLY DISCLAIMS ALL WARRANTIES OF MERCHANTABILITY OR FITNESS FOR A PARTICULAR PURPOSE. IN NO EVENT SHALL DIGI, ITS SUPPLIERS OR LICENSORS BE LIABLE FOR DAMAGES IN EXCESS OF THE PURCHASE PRICE OF THE PRODUCT, FOR ANY LOSS OF USE, LOSS OF TIME, INCONVENIENCE, COMMERCIAL LOSS, LOST PROFITS OR SAVINGS, OR OTHER INCIDENTAL, SPECIAL OR CONSEQUENTIAL DAMAGES ARISING OUT OF THE USE OR INABILITY TO USE THE PRODUCT, TO THE FULL EXTENT SUCH MAY BE DISCLAIMED BY LAW. SOME STATES DO NOT ALLOW THE EXCLUSION OR LIMITATION OF INCIDENTAL OR CONSEQUENTIAL DAMAGES. THEREFORE, THE FOREGOING EXCLUSIONS MAY NOT APPLY IN ALL CASES. This warranty provides specific legal rights. Other rights which vary from state to state may also apply.

12. Glossary of Terms

Definitions

Local Host

A device which is electrically connected to an XBee. Typically this is a microcontroller connected to the serial pins of the module.

MAC address

A unique network identifier. All network devices are required to have their own unique MAC address. The MAC address is on a sticker on your Digi device server. The number is displayed as 12 hexadecimal digits, usually starting with 00:40:9D.

Network Client

A device which communicates with an XBee through the 802.11 network.

Static IP address assignment

The process of assigning a specific IP address to a device. Contrast with assigning a device through Dynamic Host Configuration Protocol (DHCP), or Automatic Private IP Addressing (APIPA or Auto-IP).

TCP

See Transmission Control Protocol.

Temporal Key Integrity Protocol (TKIP)

Part of the IEEE 802.11i encryption standard for wireless LANs. TKIP is the next generation of the Wired Equivalent Privacy (WEP), which is used to secure 802.11 wireless LANs. TKIP provides per-packet key mixing, a message integrity check and a re-keying mechanism, and addresses several design shortcomings of the original WEP.

Transmission Control Protocol (TCP)

A set of rules (protocol) used along with the Internet Protocol (IP) to send data in the form of message units between computers over the Internet. While IP handles the actual delivery of the data, TCP handles keeping track of the individual units of data (called packets) that a message is divided into for efficient routing through the Internet. For example, when an HTML file is sent to you from a Web server, the Transmission Control Protocol (TCP) program layer in that server divides the file into one or more packets, numbers the packets, and then forwards them individually to the IP program layer. Although each packet has the same destination IP address, it may get routed differently through the network. At the other end (the client program in your computer), TCP reassembles the individual packets and waits until they have arrived to forward them to you as a single file.

TCP is known as a connection-oriented protocol, which means that a connection is established and maintained until such time as the message or messages to be exchanged by the application programs at each end have been exchanged. TCP is responsible for ensuring that a message is divided into the packets that IP manages and for reassembling the packets back into the complete message at the other end. In the Open

Systems Interconnection (OSI) communication model, TCP is in layer 4, the Transport Layer.

UDP

See User Datagram Protocol.

User Datagram Protocol (UDP)

A communications protocol that offers a limited amount of service when messages are exchanged between computers in a network that uses the Internet Protocol (IP). UDP is an alternative to the Transmission Control Protocol (TCP) and, together with IP, is sometimes referred to as UDP/IP. Like the Transmission Control Protocol, UDP uses the Internet Protocol to actually get a data unit (called a datagram) from one computer to another. Unlike TCP, however, UDP does not provide the service of dividing a message into packets (datagrams) and reassembling it at the other end. Specifically, UDP does not provide sequencing of the packets in which the data arrives, nor does it guarantee delivery of data. This means that the application program that uses UDP must be able to make sure that the entire message has arrived and is in the right order. Network applications that want to save processing time because they have very small data units to exchange (and therefore very little message reassembling to do) may prefer UDP to TCP. The Trivial File Transfer Protocol (TFTP) uses UDP instead of TCP. UDP provides two services not provided by the IP layer. It provides port numbers to help distinguish different user requests and, optionally, a checksum capability to verify that the data arrived intact.

Wi-Fi Protected Access (WPA)

A data encryption/ user authentication method for 802.11 wireless LANs. WPA uses the Temporal Key Integrity Protocol (TKIP).

WPA

See Wi-Fi Protected Access.

WPA2/802.11i

WPA with AES-based encryption (CCMP)