

## TMS320-P28016 development board

## Users Manual

Rev.A, May 2008

Copyright(c) 2008, OLIMEX Ltd, All rights reserved

## INTRODUCTION:

TMS320F28016 have very competitive pricing and is very good bargain for 32-bit DSP running at 60 Mhz, delivering 60 MMACS, 32KB Flash, 12 KB RAM, 8 channel PWM 4 of them with enhanced resolution of 150 ps(!), 2 x 8 channels 3.75 MPSP 12-bit ADCs, CAN, RS232, SPI, I2C. TMS320-P28016 board is low cost entry board for peoples on low budged who want to learn DSPs.

## BOARD FEATURES:

- MCU: TMS320F28016 32KB Flash, 12 KB RAM, 3.75 MPSP 2 x 8 channel ADCs, 8 PWM, CAN, SPI, RS232, I2C;
- JTAG connector;
- USB-to-RS232 convertor allow easy to power board and to connect to notebooks and decent computers without RS232 port;
- CAN driver and connector;
- UEXT connector with SPI, RS232, I2C for connection to other Olimex modules as MOD-NRF24Lx, MOD-MP3, etc.;
- MOTOR control connector (for add on modules with ADC, PWM, Interrupt signals available);
- User button;
- Trimmer potentiometer connected to Analog input;
- power supply LED;
- user status LED;
- RST button;
- external power supply jack for AC or DC power supply;
- Voltage regulator + power supply filtering capacitor;
- extension headers for each uC pin;
- prototype area with 0.1" step, Vcc + GND bus;
- PCB: FR-4, 1.5 mm (0,062"), green soldermask, white silkscreen component print;
- Dimensions: 100x80 mm (3.9x3.15").

## ELECTROSTATIC WARNING:

The TMS320-P28016 development board is shipped in protective anti-static packaging. The board must not be subject to high electrostatic potentials. General practice for working with static sensitive devices should be applied when working with this board.

## BOARD USE REQUIREMENTS:

**Cables:** 1.8 meter USB A-B cable to connect with USB host.

**Hardware:** Power supply adapter 4.5-6VAC or 6-9VDC (if the board is not powered from USB host).  
TMS320-JTAG for programming and debugging or similar tool.

**Software:** Texas Instruments Code Composer Studio 3.30 and drivers- available on the [www.ti.com](http://www.ti.com)

**BOARD LAYOUT:**

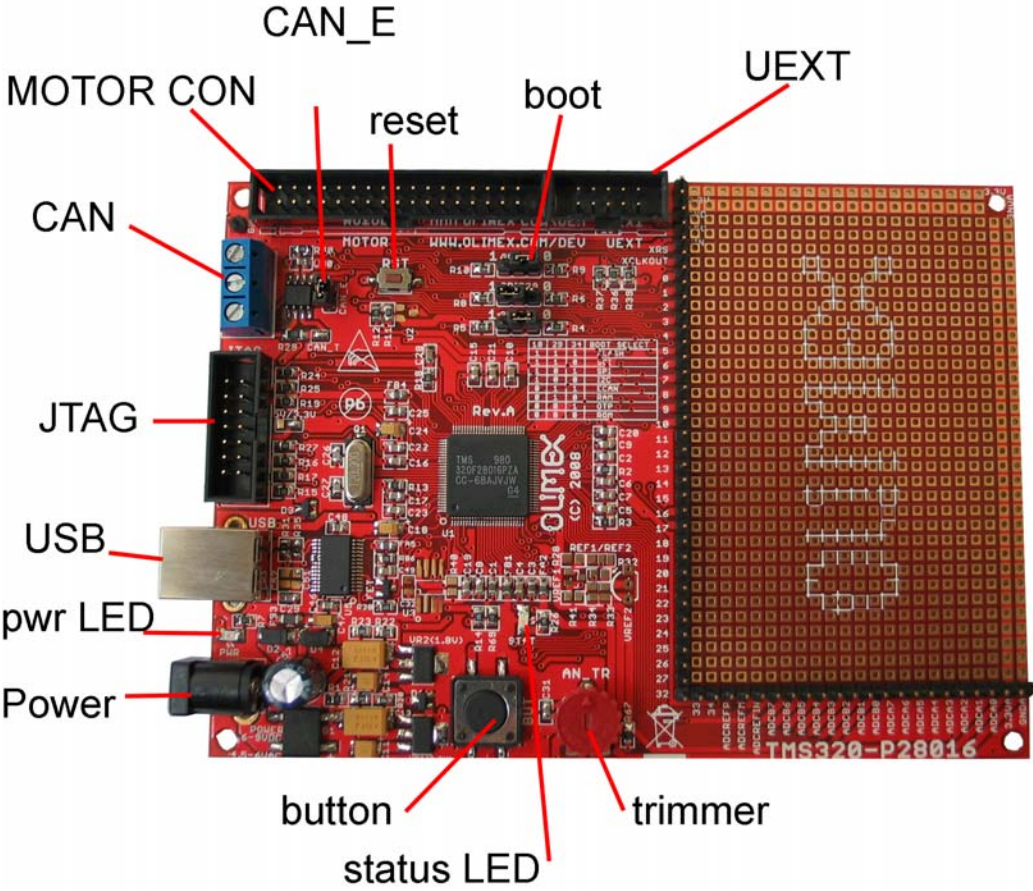

# SCHEMATIC:

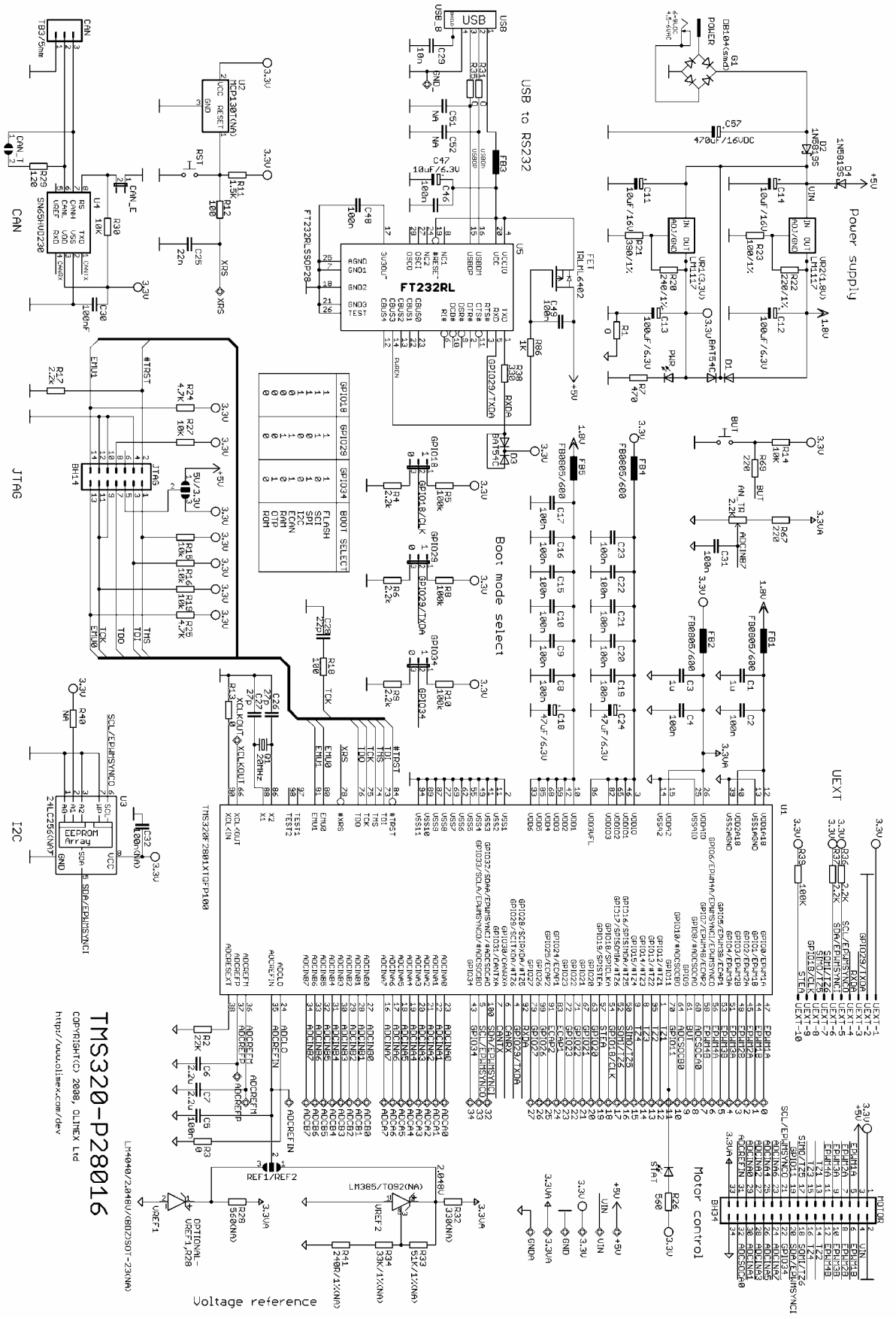

**TMS320P28016**  
 COPYRIGHT © 2008, QUALTEK LTD  
<http://www.qualtek.com/dev>

## PROCESSOR FEATURES:

The **TMS320F28016** processor has the following features:

- High-Performance Static CMOS Technology
  - 100 MHz (10-ns Cycle Time)
  - 60 MHz (16.67-ns Cycle Time)
  - Low-Power (1.8-V Core, 3.3-V I/O) Design
- JTAG Boundary Scan Support (IEEE Standard 1149.1-1990 Standard Test Access Port and Boundary Scan Architecture)
- High-Performance 32-Bit CPU (TMS320C28x)
  - 16 x 16 and 32 x 32 MAC Operations
  - 16 x 16 Dual MAC
  - Harvard Bus Architecture
  - Atomic Operations
  - Fast Interrupt Response and Processing
  - Unified Memory Programming Model
  - Code-Efficient (in C/C++ and Assembly)
- On-Chip Memory
  - 16K X 16 Flash, 6K X 16 SARAM
  - 1K x 16 OTP ROM
- Boot ROM (4K x 16)
  - With Software Boot Modes (via SCI, SPI, CAN, I<sup>2</sup>C, and Parallel I/O)
  - Standard Math Tables
- Clock and System Control
  - Dynamic PLL Ratio Changes Supported
  - On-Chip Oscillator
  - Watchdog Timer Module
- Any GPIO A Pin Can Be Connected to One of the Three External Core Interrupts
- Peripheral Interrupt Expansion (PIE) Block That Supports All 43 Peripheral Interrupts
- 128-Bit Security Key/Lock
  - Protects Flash/OTP/L0/L1 Blocks
  - Prevents Firmware Reverse Engineering
- Three 32-Bit CPU Timers
- Enhanced Control Peripherals
  - 8 PWM Outputs, 4 HRPWM Outputs With 150 ps MEP Resolution
  - 2 Capture Inputs
  - 3 32-bit Timers
- Serial Port Peripherals
  - SPI Module
  - SCI (UART) Module
  - CAN Module
  - One Inter-Integrated-Circuit (I<sup>2</sup>C) Bus
- 12-Bit ADC, 16 Channels
  - 2 x 8 Channel Input Multiplexer
  - Two Sample-and-Hold
  - Single/Simultaneous Conversions
  - Fast Conversion Rate: 267 ns - 3.75 MSPS
  - Internal or External Reference
- Up to 35 Individually Programmable, Multiplexed GPIO Pins With Input Filtering
- Advanced Emulation Features
  - Analysis and Breakpoint Functions
  - Real-Time Debug via Hardware
- Development Support Includes

- ANSI C/C++ Compiler/Assembler/Linker
  - Code Composer Studio™ IDE
  - DSP/BIOS™
  - Digital Motor Control and Digital Power Software Libraries
- Low-Power Modes and Power Savings
  - IDLE, STANDBY, HALT Modes Supported
  - Disable Individual Peripheral Clocks

# TMS320F28016 BLOCK DIAGRAM

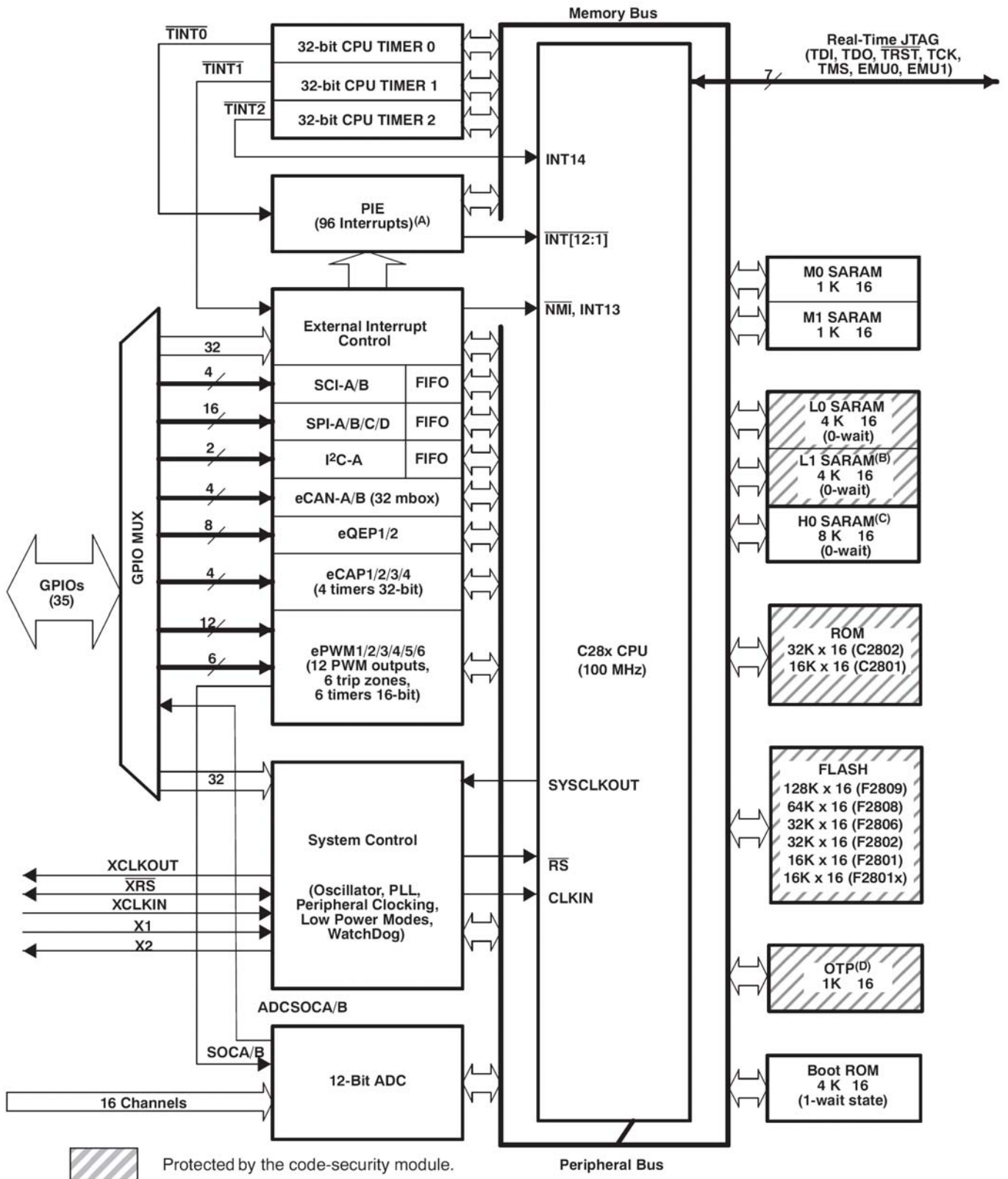

# MEMORY MAP:

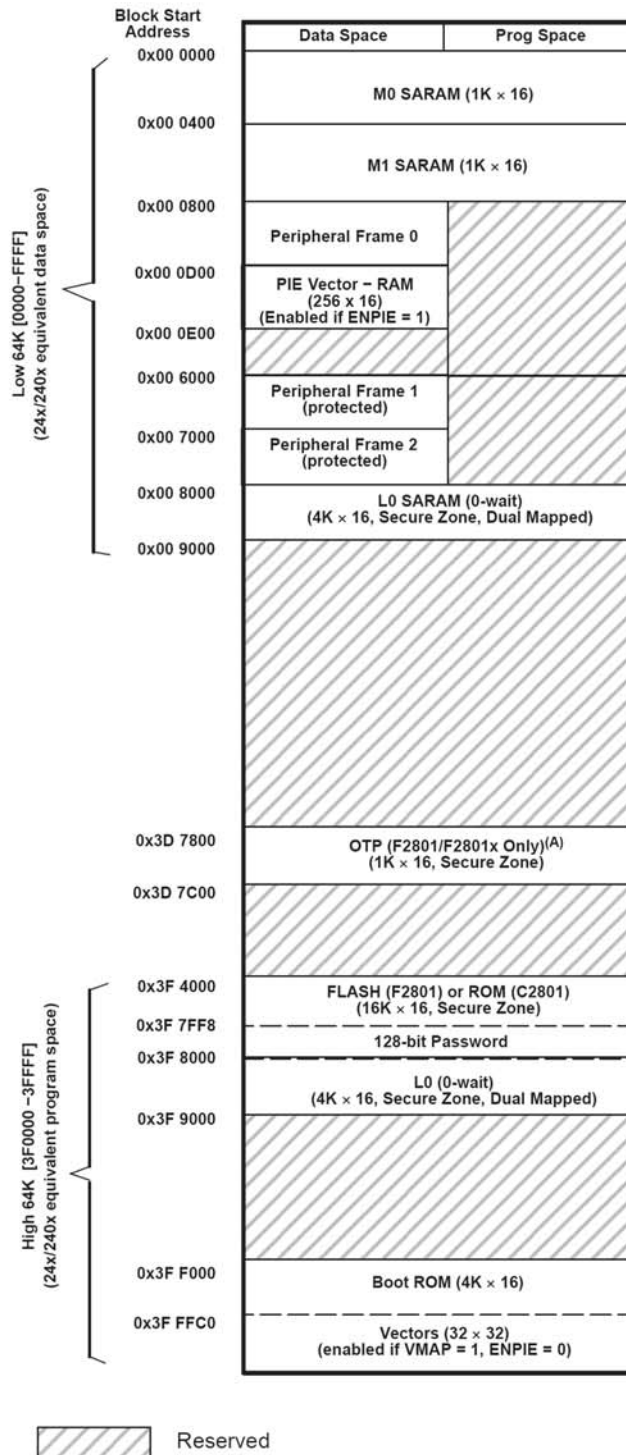

- A. The 1K x 16 OTP has been replaced with 1K x 16 ROM in C2801.
- B. Memory blocks are not to scale.
- C. Peripheral Frame 0, Peripheral Frame 1, and Peripheral Frame 2 memory maps are restricted to data memory only. User program cannot access these memory maps in program space.
- D. *Protected* means the order of Write followed by Read operations is preserved rather than the pipeline order.
- E. Certain memory ranges are EALLOW protected against spurious writes after configuration.
- F. Some locations in ROM are reserved for TI. See [Table 3-5](#) for more information.



## POWER SUPPLY CIRCUIT:

**TMS320-P28016** board can take power from POWER connector (4.5-6VAC or 6-9VDC), from VIN pin near to prototype area(5-9VDC), from MOTOR connector pin 4 (5-9VDC) and from USB connector.

The board power consumption is around 180 mA with all peripherals and MCU running at full speed.

## RESET CIRCUIT:

Reset circuit is made with RC group R11 – 1,5K and C25 – 22nF. Although on the schematic is made provision for external reset as MCP130T(SOT23 package). Manual reset is possible by the RST button.

## CLOCK CIRCUIT:

Quartz crystal 20Mhz is connected to TMS320F28016. Internal PLL circuit can multiply this frequency up to 100Mhz.

## JUMPER DESCRIPTION:

The jumpers **GPIO18**, **GPIO29** and **GPIO34** selects boot mode source. The table bellow shows boot mode variants.

MODE	DESCRIPTION	GPIO18 SPICLKA SCITXDB	GPIO29 SCITXDA	GPIO34
Boot to Flash/ROM	Jump to Flash/ROM address 0x3F 7FF6 You must have programmed a branch instruction here prior to reset to redirect code execution as desired.	1	1	1
SCI-A Boot	Load a data stream from SCI-A	1	1	0
SPI-A Boot	Load from an external serial SPI EEPROM on SPI-A	1	0	1
I2C Boot	Load data from an external EEPROM at address 0x50 on the I2C bus	1	0	0
eCAN-A Boot	Call CAN_Boot to load from eCAN-A mailbox 1.	0	1	1
Boot to M0 SARAM	Jump to M0 SARAM address 0x00 0000.	0	1	0
Boot to OTP	Jump to OTP address 0x3D 7800	0	0	1
Parallel I/O Boot	Load data from GPIO0 - GPIO15	0	0	0

Default state. Boot to M0 SARAM

**GPIO34**



**1 0**

**GPIO29**



**0 1**

**GPIO18**



**1 0**

**5V/3.3V** Must be in 3.3V position.  
Default state. **5V/3.3V**



**CAN\_T** When the jumper is closed connect 120 Ohm terminator between CAN\_L and CAN\_H busses.  
Default state closed (shorten)



**CAN\_E** This jumper enables the CAN driver U4(SN65HVD230) when is closed.  
Default state closed (shorten)



## EXTERNAL CONNECTOR DESCRIPTION:

### INPUT/OUTPUT:

One reset buttons with names **RST** – connected to TMS320F28016 pin.78 #XRS;

One user button with name **BUT** – connected to TMS320F28016 pin.61 GPIO9.

One LED – **STAT** – connected to TMS320F28016 pin.70 GPIO11;

One trimmer **AN\_TR** – connected to TMS320F28016 pin34 ADCINB7.

Power supply red LED with name **PWR** – indicates that 3.3V is present.

### PWR:

Pin #	Signal Name
1	From 4.5 to 6VAC or from 6 to 9VDC
2	GND

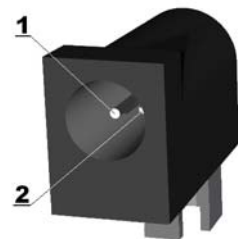

## USB:

The USB is made with USB to serial converter chip FT232RL of FTDI. RXD and TXD pins of the converter is connected to SCI\_A module of TMS320F28016 respective to GPIO29/SCITXDA (pin 4) and GPIO29/SCIRXDA (pin 92)

Pin #	Signal Name
1	+5V
2	USBDM
3	USBDP
4	GND



## UEXT:

Pin #	Signal Name	Pin #	Signal Name
1	3.3V	2	GND
3	GPIO29/TXDA	4	RXDA
5	SCL/EPWMSYNCO	6	SDA/EPWMSYNCI
7	SOMI/TZ6	8	SIMO/TZ5
9	GPIO18/CLK	10	STEA

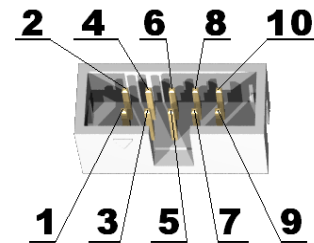

UEXT is a universal connector which Olimex uses on it's development boards to attach different "modules" on the connector there are 3.3V power supply and UART, SPI and I2C interface. Olimex have range of modules like MOD-MP3, MOD-nRF24Lx, MOD-RFID125, MOD-NOKIA6610 and many others to come.

## SPI:

The SPI is a high-speed (up to 20MHz clock), synchronous serial I/O port that allows a serial bit stream of programmed length (one to sixteen bits) to be shifted into and out of the device at a programmable bit-transfer rate. Normally, the SPI is used for communications between the DSP controller and external peripherals or another processor. Typical applications include external I/O or peripheral expansion through devices such as shift registers, display drivers, and ADCs. Multi-device communications are supported by the master/slave operation of the SPI. On the 280x, the SPI contains a 16-level receive and transmit FIFO for reducing interrupt servicing overhead.

## UART:

The serial communications interface is a two-wire asynchronous serial port, commonly known as UART. On the 28016, the SCI contains a 16-level receive and transmit FIFO for reducing interrupt servicing overhead.

## I2C:

The inter-integrated circuit (I2C) module provides an interface between a DSP and other devices compliant with Philips Semiconductors Inter-IC bus (I2C-bus) specification version 2.1 and connected by way of an I2C-bus. External components attached to this 2-wire serial bus can transmit/receive up to 8-bit data to/from the DSP through the I2C module. On the 280x, the I2C contains a 16-level receive and transmit FIFO for reducing interrupt servicing overhead.

## CAN:

This is the enhanced version of the CAN peripheral. It supports 32 mailboxes, time stamping of messages, and is CAN 2.0B-compliant.

Pin #	Signal Name
1	GND
2	CANL
3	CANH



## JTAG:

TI standard 2x7 pin JTAG connector

Pin #	Signal Name	Pin #	Signal Name
1	TMS	2	#TRST
3	TDI	4	GND
5	5V/3.3V	6	NC
7	TDO	8	10K to 3.3V
9	TCK	10	GND
11	TCK	12	GND
13	EMU0	14	EMU1

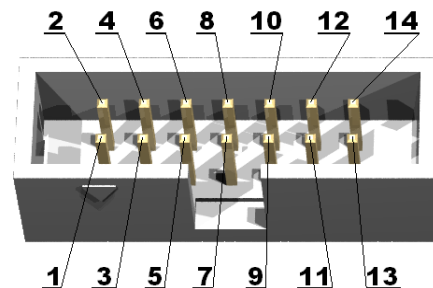

## MOTOR CONTROL CONNECTOR:

MOTOR control connector provides signals for add on modules with ADC, PWM, Interrupt signals available on it

Pin #	Signal Name	Pin #	Signal Name
1	3.3V	2	GND
3	+5V	4	VIN
5	EPWM1A	6	EPWM1B
7	EPWM2A	8	EPWM1B
9	EPWM3A	10	EPWM3B
11	EPWM4A	12	EPWM4B
13	TZ1	14	TZ2
15	TZ3	16	TZ4
17	SIMO/TZ5	18	SOMI/TZ6
19	GPIO11	20	SDA/EPWMSYNCI
21	SCL/EPWMSYNCO	22	GPIO34
23	ADCINA6	24	ADCINA7
25	ADCINA4	26	ADCINA5
27	ADCINA2	28	ADCINA3
29	ADCINA0	30	ADCINA1
31	ADCREFIN	32	ADCSOCA0
33	3.3VA	34	GNDA

## PROTO AREA:

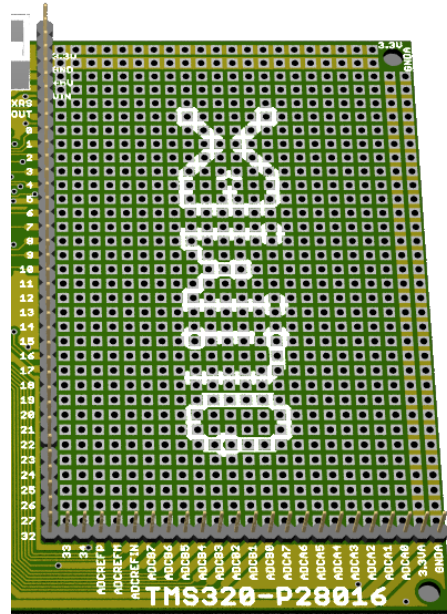
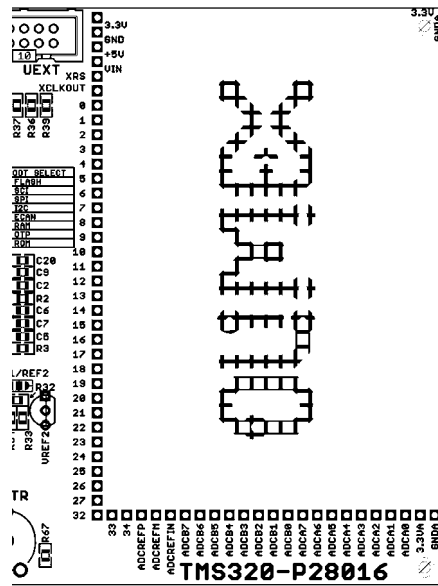

Pin #	Signal Name	Pin #	Signal Name	Pin #	Signal Name
3.3V	3.3V	14	TZ3	ADCREFP	ADCREFP
GND	3.3VGND	15	TZ4	ADCREFM	ADCREFM
+5V	+5V	16	SIMO/TZ5	ADCREFIN	ADCREFIN
VIN	VIN	17	SOMI/TZ6	ADCB7	ADCINB7
XRS	XRS	18	GPIO18/CLK	ADCB6	ADCINB6
XCLKOUT	XCLKOUT	19	STEA	ADCB5	ADCINB5
0	EPWM1A	20	GPIO20	ADCB4	ADCINB4
1	EPWM1B	21	GPIO21	ADCB3	ADCINB3
2	EPWM2A	22	GPIO22	ADCB2	ADCINB2
3	EPWM2B	23	GPIO23	ADCB1	ADCINB1
4	EPWM3A	24	ECAP1	ADCB0	ADCINB0
5	EPWM3B	25	ECAP2	ADCA7	ADCINA7
6	EPWM4A	26	GPIO26	ADCA6	ADCINA6
7	EPWM4B	27	GPIO27	ADCA5	ADCINA5
8	ADCSOCA0			ADCA4	ADCINA4
9	BUT	32	SDA/EPWMSYNCI	ADCA3	ADCINA3
10	ADCSOCB0	33	SCL/EPWMSYNCO	ADCA2	ADCINA2
11	GPIO11	34	GPIO34	ADCA1	ADCINA1
12	TZ1			ADCA0	ADCINA0
13	TZ2				

# MECHANICAL DIMENSIONS:

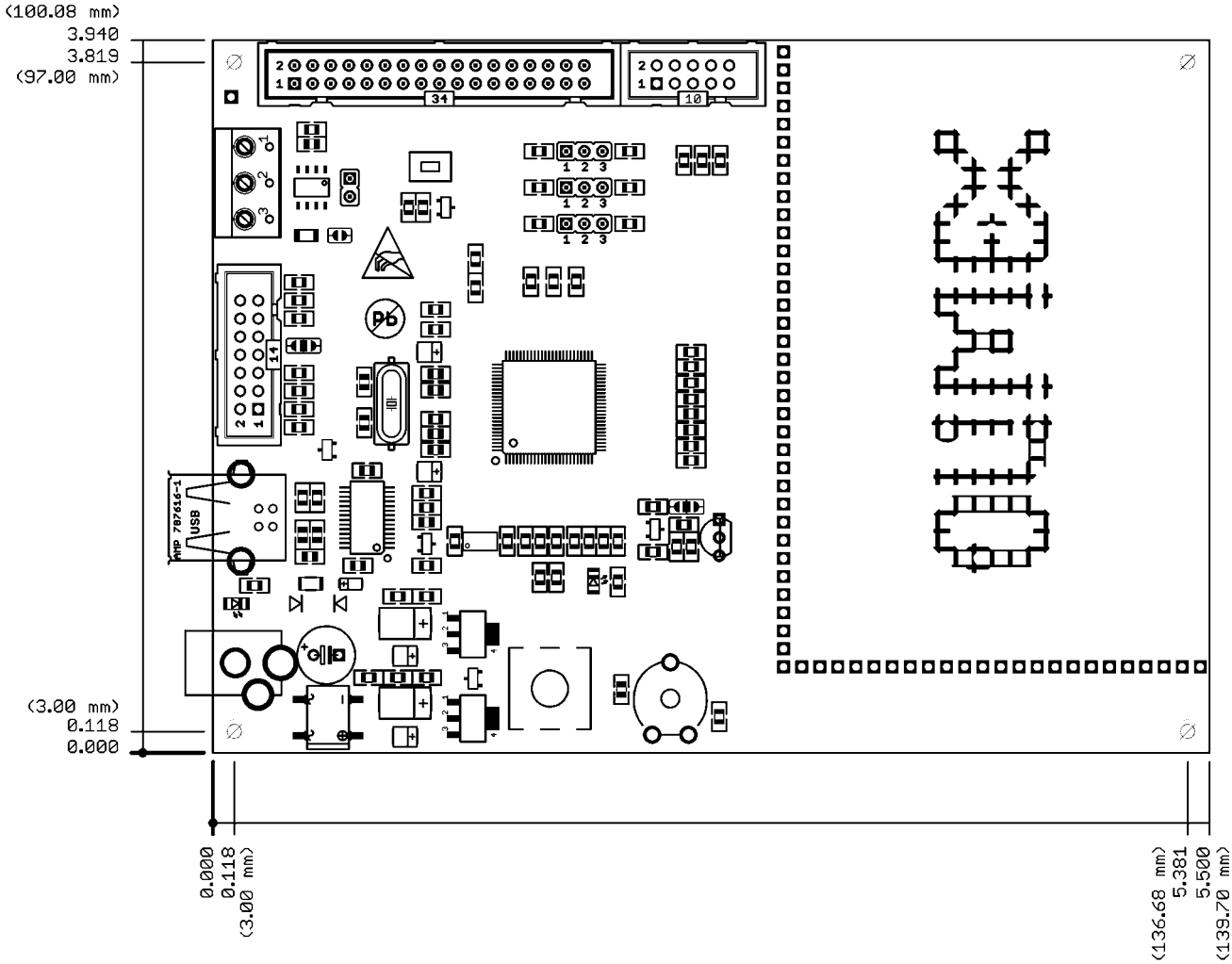

## **AVAILABLE DEMO SOFTWARE:**

DEMO1. Blink LED C Source and CCS project files

Blinks the on-board LED.

DEMO2. RS232 C Source and CCS project files

Echo at 9600, 8data bits, 1 stop, no parity

DEMO3. ADC read C source and CCS project files

Blinks the on-board LED according to the read by the ADC  
AN\_TR trimer potentiometer value



## ORDER CODE:

**TMS320-P28016 – assembled and tested (no kit, no soldering required)**

### **How to order?**

**You can order to us directly or by any of our distributors.**

**Check our web [www.olimex.com/dev](http://www.olimex.com/dev) for more info.**



All boards produced by Olimex are RoHS compliant

### **Revision history:**

REV.A create May 2008

**Disclaimer:**

© 2008 Olimex Ltd. All rights reserved. Olimex®, logo and combinations thereof, are registered trademarks of Olimex Ltd. Other terms and product names may be trademarks of others.

The information in this document is provided in connection with Olimex products. No license, express or implied or otherwise, to any intellectual property right is granted by this document or in connection with the sale of Olimex products.

Neither the whole nor any part of the information contained in or the product described in this document may be adapted or reproduced in any material from except with the prior written permission of the copyright holder.

The product described in this document is subject to continuous development and improvements. All particulars of the product and its use contained in this document are given by OLIMEX in good faith. However all warranties implied or expressed including but not limited to implied warranties of merchantability or fitness for purpose are excluded.

This document is intended only to assist the reader in the use of the product. OLIMEX Ltd. shall not be liable for any loss or damage arising from the use of any information in this document or any error or omission in such information or any incorrect use of the product.